

systemtronic

EMOTIONS & SOLUTIONS

# We create solutions, we inspire emotions

systemtronic

<sup>EN</sup> Since 1988 Systemtronic has been manufacturing auxiliary contemporary furniture and developing solutions to cover pending needs of homes and facilities. Systemtronic is synonymous with quality, design, flexibility and excellence.

Our products are manufactured entirely in Europe, certified by AIDIMME and committed to the environment.

The brand has a range of attractive complements, including tasteful timeless pieces with practical details and finishes that combine in multiple spaces.

Systemtronic continues reinventing itself.

By observing the market and listening to customer's needs, products are adapted to the demand, developing and offering new solutions.

Our team is dynamic, close and committed, and offering an easy communication to the client, providing personalized attention and excellent after-sales service.

<sup>ES</sup> Desde 1988 Systemtronic fabrica mobiliario contemporáneo auxiliar y desarrolla soluciones pendientes por cubrir en el hogar e instalaciones. Systemtronic es sinónimo de calidad, diseño, flexibilidad y excelencia.

Nuestros productos son fabricados 100% en Europa, certificados por AIDIMME y comprometidos con el medioambiente.

Ofrecemos complementos con apariencia atractiva, piezas de buen gusto y atemporales, con detalles prácticos y acabados que combinan en cualquier espacio.

Systemtronic no deja de reinventarse. Observamos y escuchamos las necesidades del mercado y del cliente para adaptar nuestros productos según la demanda, desarrollando y aportando nuevas soluciones.

El colectivo de Systemtronic es dinámico, cercano y comprometido, y facilita la comunicación con el cliente brindando una atención personalizada y un servicio de posventa excelente.

# A whole world of

systemtronic

<sup>EN</sup> Systemtronic's products have been included in the interior design of countless projects around the world.

These are some of the architecture studios we have worked with:

<sup>ES</sup> Los productos de Systemtronic han sido incluidos en el interiorismo de numerosos proyectos alrededor del mundo.

*Estos son algunos estudios de arquitectura con los que hemos trabajado:*

GCA Architects, David Chipperfield Architects, De Planta & Associés Architectes, Fokkema & Partners Architecten, Fran Silvestre Arquitectos, CBRE, BAROZZI VEIGA, Herzog & de Meuron, IA Interior Architects, RBTA – Ricardo Bofill Taller de Arquitectura.

These are some of our final clients:

*Entre nuestros clientes finales están:*

Amazon, Amorepacific Corporation, Banco Sabadell, BBVA, Google, Berghotel Maibrunn, BNP Paribas, Cartier, Facial Clinique, Firmdale Hotels, La Casa Agency, ILUNION Hotels, CaixaBank, Apple, Hotel Sixtytwo, AXA, Palau de Congressos de Catalunya, Meliá Hotels & Resorts, Rumailah Hospital, Mohammed VI Polytechnic University, Palma Sport & Tennis Club, Hipotels, Caroll, H10 Hotels, Novartis.

**Australia**

**Austria**

**Belgium**

**Canada**

**Chile**

**Czech Republic**

**Ecuador**

**Faroe Islands**

**Finland**

**France**

**Germany**

**Greece**

**Holland**

**Hong Kong**

**India**

**Ireland**

**Israel**

**Italy**

**Japan**

**Korea**

**Kuwait**

**Lebanon**

**Luxembourg**

**Morocco**

**Norway**

**Poland**

**Portugal**

**Puerto Rico**

**Réunion Island**

**Russia**

**Slovenia**

**Spain**

**Sweden**

**Switzerland**

**Tunisia**

**United Arab Emirates**

**United Kingdom**

**United States**

## 35 years of timeless emotions

Fernando Gil  
CEO



## What moves you at 35?

<sup>EN</sup> Systemtronic have been present in the market for over 35 years due to the hard work and effort on satisfying the needs of those who acquire our products, in an increasingly competitive, changing and demanding environment.

If society evolves, so do we, never forgetting our essence: at Systemtronic, we create solutions and inspire emotions. Our catalog is increasingly tailored to all kinds of spaces and functions, featuring products from talented designers as well as those developed within the company itself.

Our daily challenge is the quality of the offered products, that's why we work actively in the training of our employees, in addition to keeping an thorough control of the manufacturing processes in order to find their critical points and apply on them continuous improvement.

<sup>ES</sup> *La permanencia de Systemtronic en el mercado durante más de 35 años está avalada por el trabajo y el esfuerzo que ponemos en satisfacer las necesidades de las personas que adquieren nuestros productos, en un ambiente cada vez más competitivo, cambiante y exigente.*

*Si la sociedad evoluciona, nosotros también, sin olvidar jamás nuestra esencia: en Systemtronic creamos soluciones e inspiramos emociones. Nuestro catálogo se adecúa cada vez más a todo tipo de espacios y funciones e incluye lo mismo productos de talentosos diseñadores que otros desarrollados dentro de la propia empresa.*

*Nuestro reto diario es la calidad del producto que ofrecemos, para lo cual trabajamos de forma activa en la formación de nuestros empleados, además de llevar un control exhaustivo de los procesos de fabricación con el fin de encontrar sus puntos críticos y ejercer sobre ellos una mejora continua.*

# Aranda Aloy Enblanc, Hugo Tejada, Kodai Iwamoto, La Galería Estudio, Lluïsa Morató, Mermelada Estudio, Pablo Gironés, Paula Chacartegui, Tomoya Tabuchi, Víctor Carrasco, Fernando Gil.

Designers

Aranda Aloy Enblanc



**EN** Aranda Aloy Enblanc develops projects in the field of Industrial Design, Graphic Communication and Design of Spaces.

**ES** *Aranda Aloy Enblanc desarrolla proyectos en el ámbito del Diseño Industrial, la Comunicación Gráfica y el Diseño de Espacios.*

Hugo Tejada



**EN** Spanish designer who has collaborated with various companies related to lighting and furniture products.

**ES** *Diseñador español que ha colaborado con diversas empresas relacionadas con productos de iluminación y mobiliario.*

Kodai Iwamoto



**EN** Japanese designer who has actively collaborated with numerous furniture brands and participated in the most important fairs in the sector.

**ES** *Diseñador japonés que ha colaborado activamente con numerosas marcas de mobiliario y participado en las más importantes ferias del sector.*

La Galería Estudio



**EN** Creative studio specializing in Interior Design, Graphic Design, and ephemeral spaces, based in Valencia.

**ES** *Estudio creativo de Interiorismo, Diseño Gráfico y espacios efímeros, con sede en Valencia.*

Lluïsa Morató



EN Spanish designer with a multidisciplinary training and a global vision when facing each project.

ES *Diseñadora española con una formación multidisciplinar y una visión global a la hora de afrontar cada proyecto.*

Mermelada Estudio



EN Mermelada Estudio is an international product design studio. They work with ideas, giving a special importance to the conceptual and formal investigation.

ES *Mermelada Estudio es una firma centrada en el diseño industrial. Trabajan con ideas, dando una especial importancia a la investigación conceptual y formal.*

Tomoya Tabuchi



EN Japanese designer with extensive experience in the design, research and development of furniture manufacturing. Founder of Office for Creation.

ES *Diseñador japonés con amplia experiencia en el diseño, la investigación y el desarrollo de la fabricación de muebles. Fundador de Office for Creation.*

Victor Carrasco



EN Spanish designer with extensive experience who has developed and positioned international brands with remarkable added value, thanks to his passion for synthesis and sustainable growth.

ES *Diseñador español de amplia experiencia que ha desarrollado y posicionado marcas internacionales con notable valor añadido, gracias a su pasión por la síntesis y el crecimiento sostenible.*

Pablo Gironés



EN Spanish designer with extensive experience. He has collaborated with numerous companies in defining their product strategies, such as Punt Mobles and Mad Lab.

ES *Diseñador español con extensa experiencia. Ha colaborado con numerosas empresas en la definición de sus estrategias de producto, como Punt Mobles y Mad Lab.*

Paula Chacartegui



EN Spanish designer specialized in luxury design and crafts. She currently works in the interior design office am29, from where she develops products for the hotel sector.

ES *Diseñadora española especializada en diseño de lujo y artesanía. Actualmente trabaja en el estudio de diseño de interiores am29, desde donde desarrolla productos para el sector hotelero.*

Fernando Gil



EN Technical designer with a profound interest in the simplicity of forms and their functionality. His meticulous approach and commitment to excellence have elevated Systemtronic to new heights, offering products that combine aesthetics and utility in an exceptional manner.

ES *Diseñador técnico con un profundo interés por la simplicidad de las formas y su funcionalidad. Su enfoque meticuloso y su compromiso con la excelencia han elevado Systemtronic a nuevas alturas, ofreciendo productos que combinan estética y utilidad de manera excepcional.*



## LAMPS

	<b>FLORA</b> <small>NEW!</small>	16
---	----------------------------------	----

## FAMILY PRODUCT

	Crepe Plant Pot	22
	Crepe Umbrella Stand	28
	<b>CREPE UMBRELLA STAND &amp; PLANT POT</b> <small>NEW!</small>	34

## AUXILIARY FURNITURES

	Hold	40
	Hold Daily	44
	Ben	50

## TABLES

	Dina	54
	Celes	60
	Mill	68
	Laura	72

## SEPARATORS

	Malva	76
	Parban	80

## PLANT POTS

	Green Cloud	86
---	-------------	----

	Green Light	94
---	-------------	----

	Conee Plant Pot	100
	Conee Pouf	106

## PAPER BINS

	Drop	112
---	------	-----

	Drop Mini	118
---	-----------	-----

	Drop Top	120
---	----------	-----

	Drop Top Triple	124
--	-----------------	-----

## UMBRELLA STANDS

	Drop Out	130
---	----------	-----

	Sou	134
---	-----	-----

	Forrein	138
---	---------	-----

## TELEVISION ACCESSORIES

	Sita	142
---	------	-----

	Sitabo	148
---	--------	-----

## CLOCK

	Nube	154
---	------	-----

## BOOKSHELVES

	Baldas	156
---	--------	-----

	Usio	160
---	------	-----

	Koku	164
---	------	-----

## MAGAZINE RACKS

	Mott	168
---	------	-----

	Zin	172
---	-----	-----

## FIRE EXTINGUISHER SUPPORT

	Faya	174
---	------	-----

## ASHTRAY

	Fum	178
---	-----	-----

## TENSABARRIER

	Trec	180
---	------	-----

## OFFICE ACCESSORIES

	Store	182
---	-------	-----

	Office set	186
---	------------	-----

## EXHIBITORS

	Lit	192
---	-----	-----

	Flap	196
---	------	-----

	Modulor	198
---	---------	-----

	Iflag	200
---	-------	-----

	Atria	202
---	-------	-----

## COAT RACKS

	Naname	208
---	--------	-----

	Second Tree	212
---	-------------	-----

	Second Tree Wall	216
---	------------------	-----

	Ker	220
---	-----	-----

	Elica	224
--	-------	-----

	Elica Mini	226
---	------------	-----

	Branch	230
---	--------	-----

	Inlin	234
---	-------	-----

	<b>CANTHA</b> <small>NEW!</small>	238
---	-----------------------------------	-----

	Inper	244
---	-------	-----

	Climb	246
---	-------	-----

	Pointo	250
---	--------	-----

	Buraco	254
---	--------	-----

Find your product.

IT'S UP TO YOU

Finishes, colors....

258

**When the product  
becomes art**

**When art inspires  
spaces**





# Flora

**EN** With a design of minimalist lines, Flora combines two functions, a wireless lamp and a beautiful vase.

**ES** *Con un diseño de líneas minimalistas, Flora combina dos funciones, una lámpara inalámbrica y un hermoso florero.*

Flora by  
La Galería Estudio

FLORA

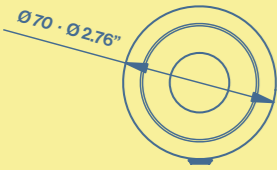
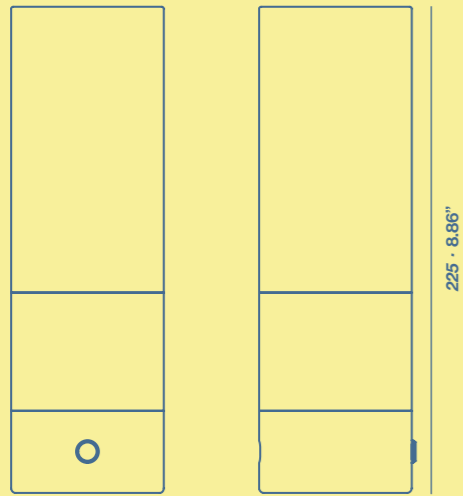

mm · inches

# Flora

EN Crafted from aluminum and available in five carefully selected finishes to stand out in any setting.

ES Fabricada en aluminio y disponible en cinco acabados cuidadosamente seleccionados para destacar en cualquier entorno.



## Aluminum. Light and life in one place.

Aluminio.  
Luz y vida en un solo lugar.





EN Plant pots manufactured in aluminum folded sheet and painted in different colors.

ES *Jardineras fabricadas en plancha de aluminio plegada y pintada en diferentes colores.*

Crepe Plant Pot by  
Victor Carrasco

# Crepe



CREPE\_H

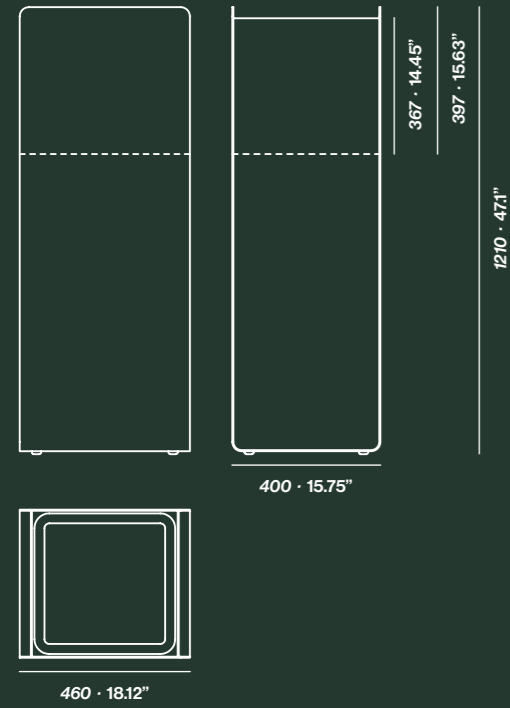

CREPE\_S

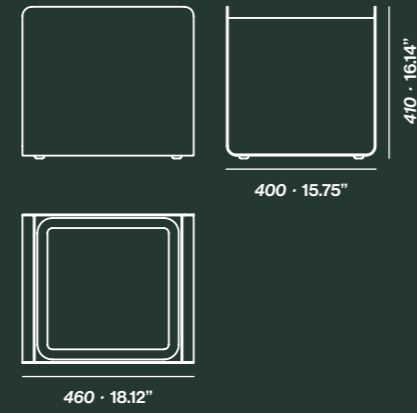

CREPE\_L

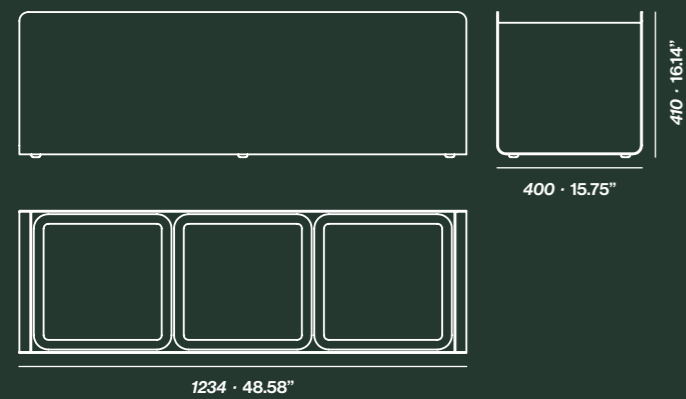

mm · inches

Crepe



**Multiple sizes and finishes.  
Aluminum folded sheet.**

*Múltiples tamaños y acabados.  
Chapa plegada de aluminio.*

**EN They must include:**  
One tray and one 25-liter pot, available in our price list.

**ES Deben incluir:**  
*Un plato y una maceta de 25 litros, disponibles en nuestra tarifa de precios.*



**EN** Umbrella stands manufactured in aluminum folded sheet and painted in different colors. They include a grid to separate the umbrellas and a plate to collect the water.

**ES** *Paragüeros fabricados en plancha de aluminio plegada y pintada en diferentes colores. Incluyen una rejilla para separar paraguas y un plato para recoger el agua.*

Crepe Umbrella Stand by  
Victor Carrasco

# Crepe Umbrella Stand





CREPE\_L Umbrella Stand

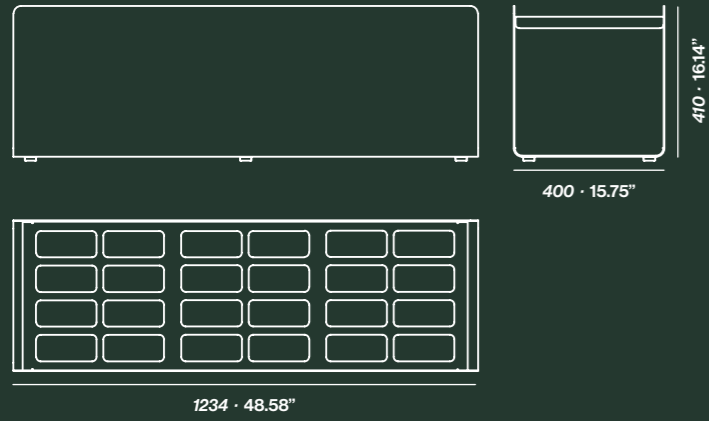

CREPE\_S Umbrella Stand

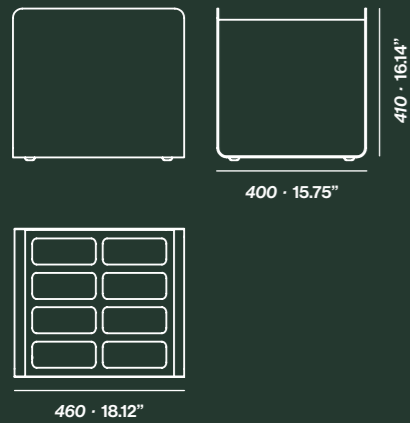

mm · inches

# Crepe Umbrella Stand



**Aluminum.**  
**Indoor and outdoor.**  
**Great capacity.**

*Aluminio.*  
*Uso interior y exterior.*  
*Gran capacidad.*



# Crepe Umbrella Stand & Plant Pot

**EN** The perfect solution for organizing and storing umbrellas while simultaneously beautifying the space with plants. There are two different models that offer varying capacities for each element.

**ES** *La solución perfecta para organizar y almacenar los paraguas y al mismo tiempo embellecer el espacio con plantas. Existen dos modelos distintos que ofrecen mayor o menor capacidad de uno u otro elemento.*

Crepe Umbrella Stand & Plant Pot by  
Victor Carrasco

CREPE UMBRELLA STAND-PLANT POT

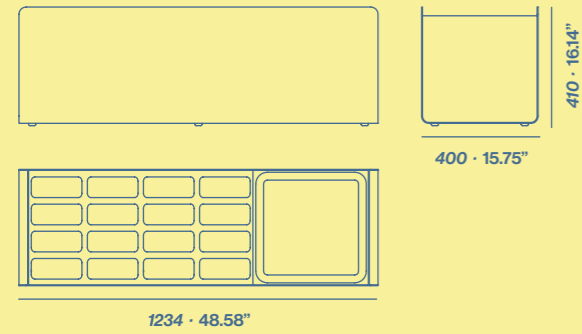

CREPE PLANT POT-UMBRELLA STAND

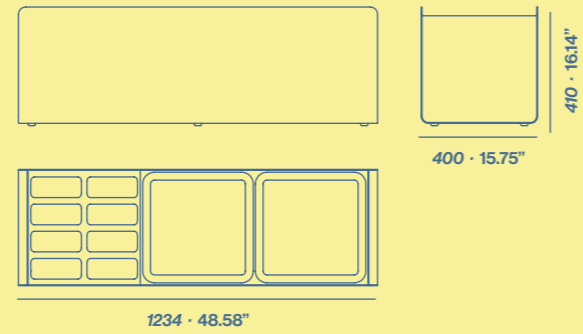

mm · inches

<sup>EN</sup> Made from aluminum, this product features durable and resistant finishes that allow it to endure water exposure while maintaining its shape and functionality.

<sup>ES</sup> Fabricado en aluminio, lo que sumado a sus acabados duraderos y resistentes le permite soportar la exposición al agua sin perder su forma ni su funcionalidad.

# Crepe Umbrella Stand & Plant Pot



**Aluminum.**  
**Indoor and outdoor.**  
**Great capacity.**

*Aluminio.*  
*Uso interior y exterior.*  
*Gran capacidad.*



<sup>EN</sup> Due to its design and functionality, this auxiliary element fits perfectly into multiple spaces: bedrooms, kitchens, bathrooms, offices... Manufactured in folded steel sheet and coated with oven thermoset powder paint.

<sup>ES</sup> Elemento auxiliar que gracias a su diseño y funcionalidad encaja perfectamente en múltiples espacios: habitaciones, cocinas, baños, oficinas... Fabricado en plancha de acero plegada y recubierta con pintura en polvo termoendurecida al horno.

Hold by  
Aranda Aloy Enblanc

# Hold



**HOLD HIGH**

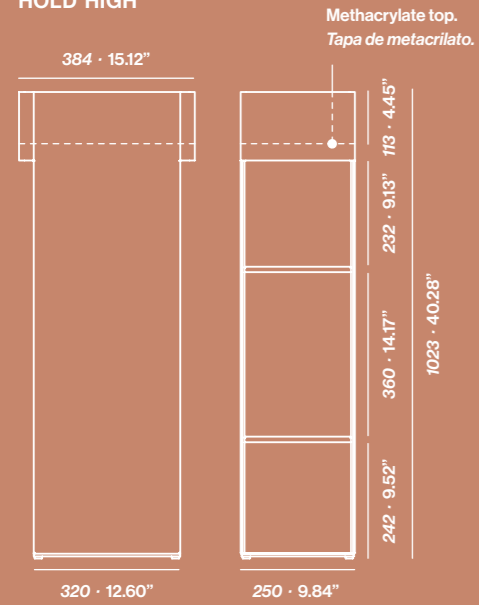

**HOLD OFFICE**

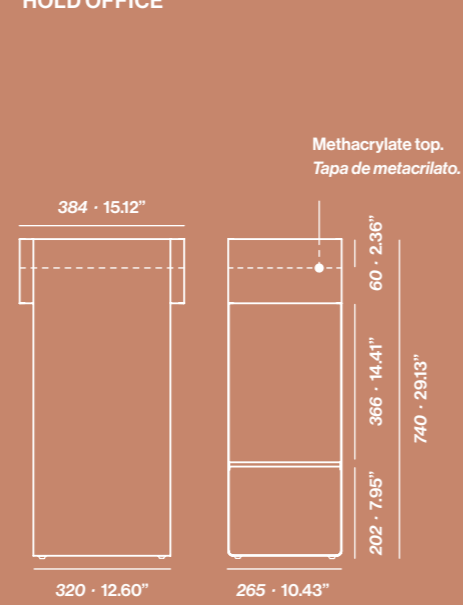

**HOLDRH**

Accessory wheels.  
Ruedas accesorio.



**HOLDRO**

Accessory wheels.  
Ruedas accesorio.



**HOLD**

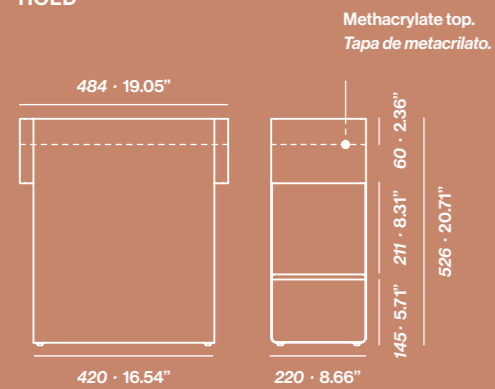

**HOLDE**

Lift element for methacrylate top.  
Accesorio elevador de la tapa metacrilato.

Only for HOLD HIGH.  
Solo para HOLD HIGH.

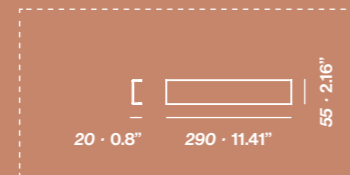

**HOLDRS**

Accessory wheels.  
Ruedas accesorio.



mm · inches

**Hold**



**Fits into multiple spaces.**

*Encaja en múltiples espacios.*

**EN** Auxiliary furniture specific for workspaces. It's closed at the back side. It has a great capacity and movement facility thanks to its casters of 64 mm of diameter. Available in two versions: Hold Daily DR with door and locker or Hold Daily BX without door. The box is offered as an option. Manufactured in folded steel sheet and coated with oven thermoset powder paint.

**ES** Mueble auxiliar específico para espacios de trabajo. Cerrado por detrás, con gran capacidad y facilidad de movimiento gracias a sus ruedas especiales de 64 mm de diámetro. Disponible en dos versiones: Hold Daily DR con puerta y cerradura o Hold Daily BX sin puerta. Se ofrece el cajón de forma opcional. Fabricado en plancha de acero plegada y recubierta con pintura en polvo termoendurecida al horno.

Hold Daily by  
Aranda Aloy Enblanc

# Hold Daily

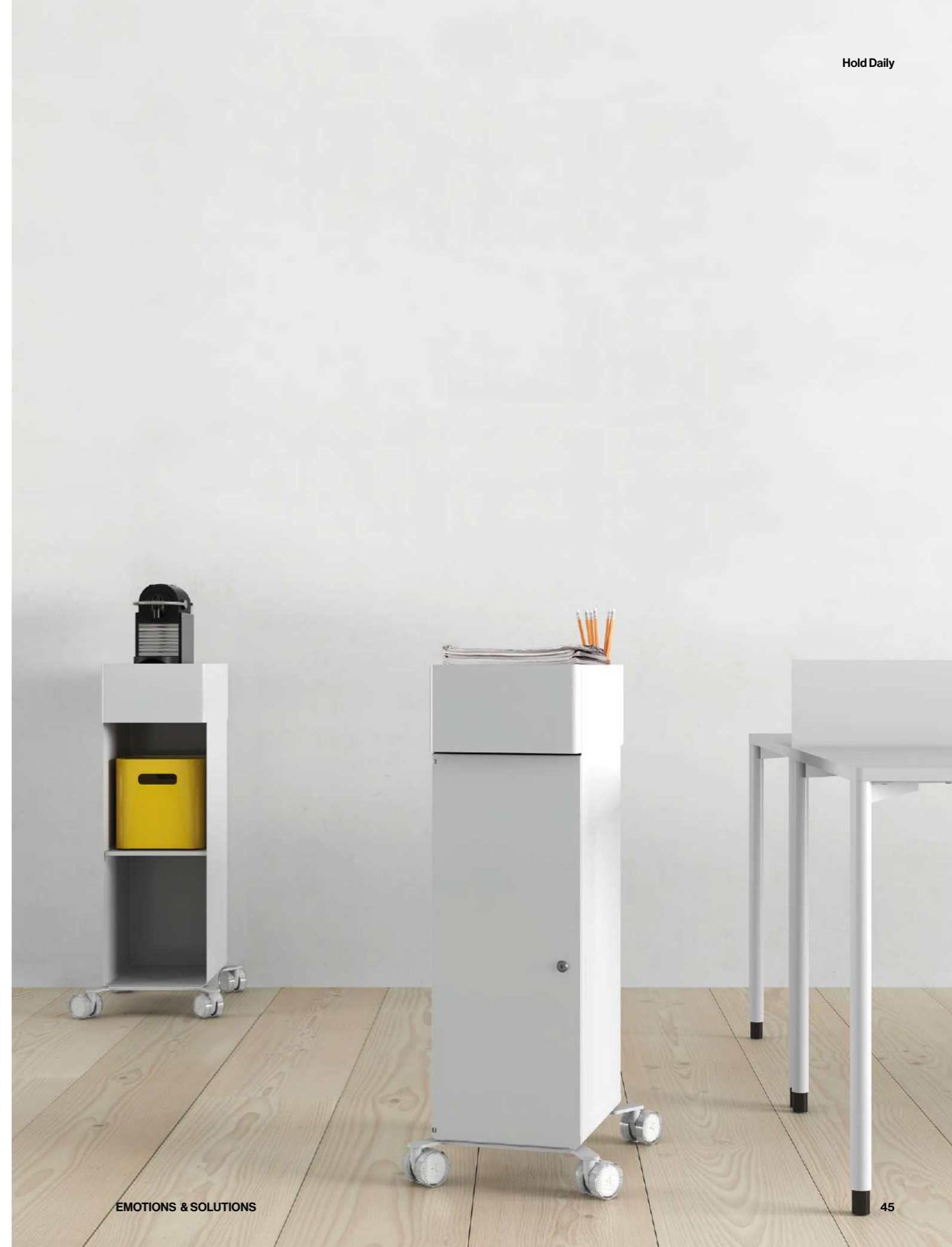



01  
WORK  
PLACE



HOLD DAILY DR

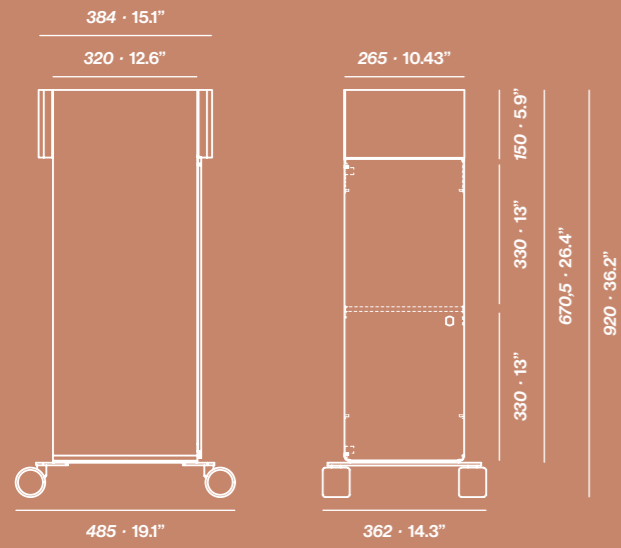

HOLD DAILY BX

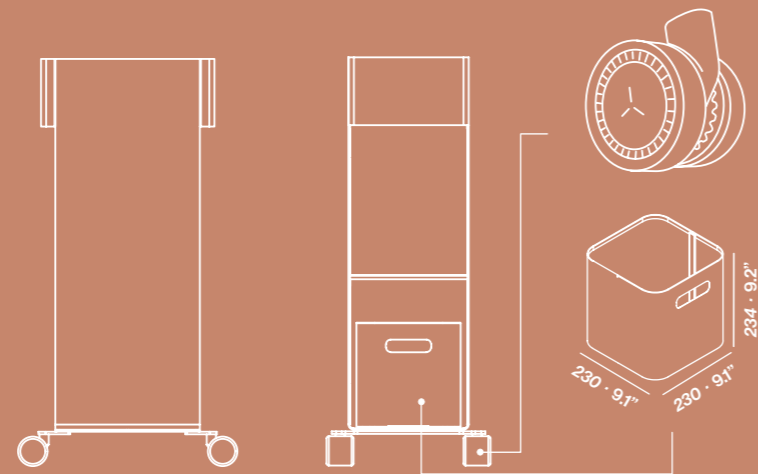

mm · inches

# Hold Daily



**It can be whatever you want.**

*Puede ser lo que quieras.*

**EN** Ben, versatile, compact auxiliary furniture, with easy mobility and displacement. It stands out for the dimension of its wheels finished in natural oak and its solid natural oak wood knob. Made of steel and coated with oven thermoset powder paint.

**ES** Ben, mueble auxiliar versátil, compacto, de fácil movilidad y desplazamiento. Destaca por la dimensión de sus ruedas acabadas en roble natural y su pomo de madera maciza de roble natural. Fabricado en acero y pintado con pintura en polvo termoendurecida lacada al horno.

Ben by  
Aranda Aloy Enblanc

# Ben



BEN

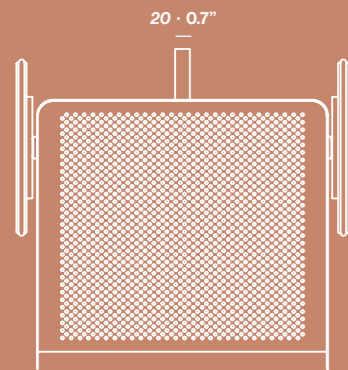
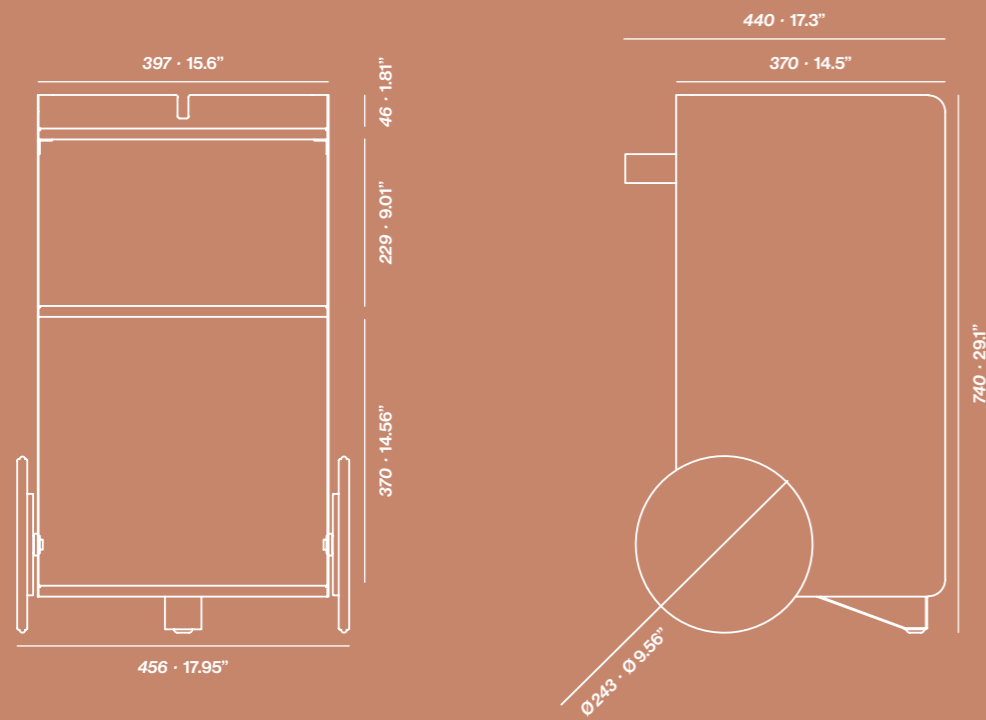

mm · inches

# Ben

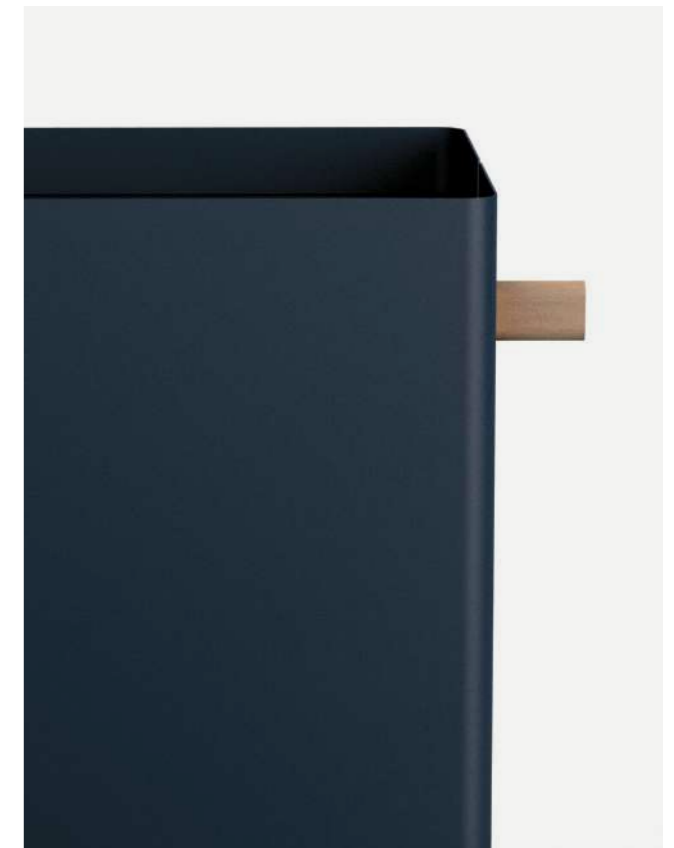

**Easy mobility.  
Versatile.**

*Fácil movilidad  
Versátil.*

<sup>EN</sup> The depth of the Dina tables allows their use in both contract and home spaces. Its rounded corners give it an organic and modern design. Available in three heights and four top sizes. The structure is made of extruded aluminum and its beveled top is made of MDF with an industrialized oak laminate finish.

<sup>ES</sup> La profundidad de las mesas Dina permite su uso tanto en espacios contract como en hogar. Sus esquinas redondeadas le aportan un diseño orgánico y actual. Disponibles en tres alturas y cuatro tamaños de tablero. La estructura está fabricada en aluminio extrusionado y su sobre biselado es de MDF con acabado laminado industrializado roble.

Dina by  
STC Studio

# Dina



ES Estanterías pertenecientes a la colección Wing.  
Para más información, consultar catálogo Wing.

EN Shelving belonging to the Wing collection.  
For more information, consult the Wing catalogue.



DINA

Board sizes / *Tamaños de tablero*

2000x900 · 78.74x35.44"

1600x900 · 63x35.44"

1200x900 · 47.25x35.44"



Heights / *Alturas*

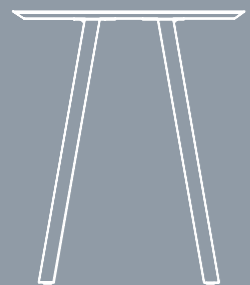

1050 · 41.34"



880 · 34.65"



750 · 29.53"

Board size / *Tamaño de tablero*

800x800 · 31.50x31.50"

Height / *Altura*

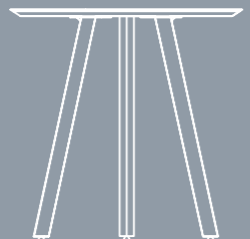
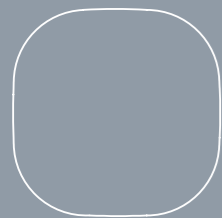

750 · 29.53"

mm · inches

# Dina



**Just what your space needs.**

*Justo lo que tu espacio necesita.*

EN Set of tables of different heights and board sizes combinable with each other, made entirely in aluminum and suitable for outdoor use.

ES Conjunto de mesas a diferentes alturas y tamaños de tablero combinables entre sí, fabricadas íntegramente en aluminio, aptas para su uso en exterior.

Celes by  
Victor Carrasco

# Celes



CELESAB

CELESAL

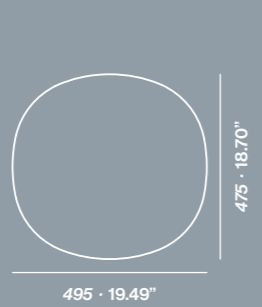
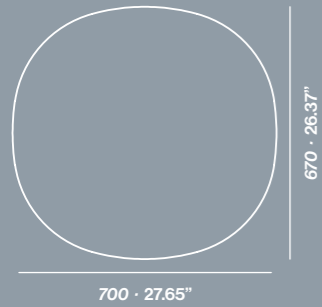
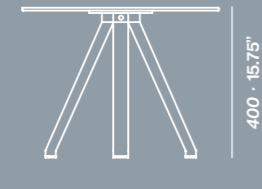
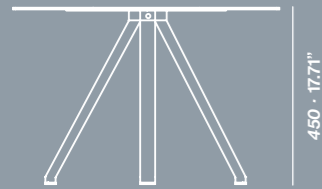

CELESAM

CELESAS

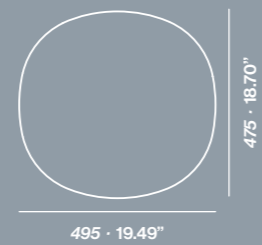
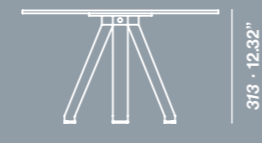
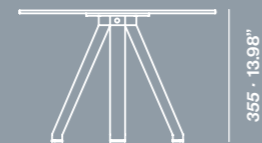

mm · inches

Celes



**Different sizes and finishes.  
Combinable with each other.  
Indoor and outdoor.**

*Diferentes tamaños y acabados.  
Combinables entre sí.  
Uso interior y exterior.*





EN Version of Celes table for interiors, with steel tube legs and MDF tabletop finished in natural oak or HPL white or black.

ES *Versión de mesas Celes para interior con patas de tubo de acero y tablero MDF acabado en roble natural o HPL blanco o negro.*

Celes by  
Victor Carrasco

# Celes

CELESMX

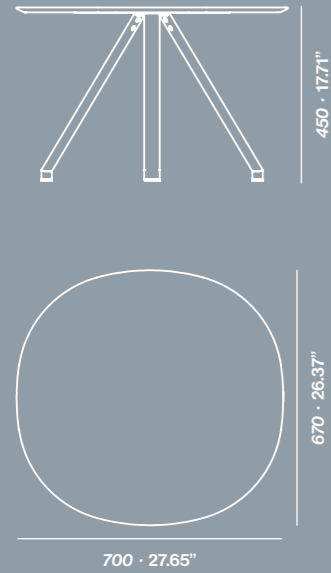

CELESML

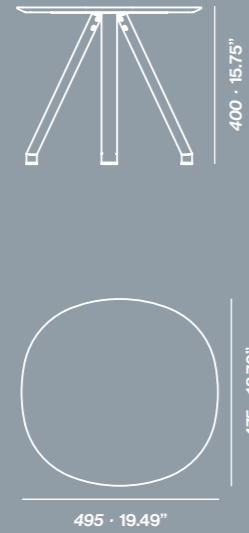

CELESMM

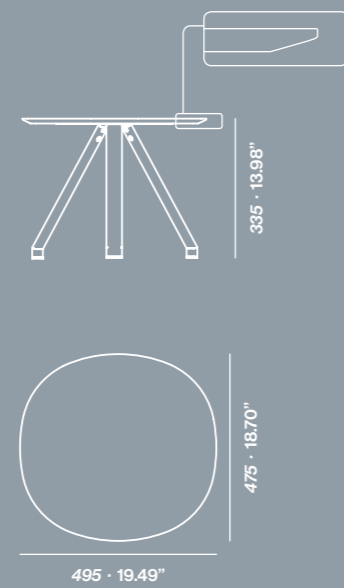

CELESMS

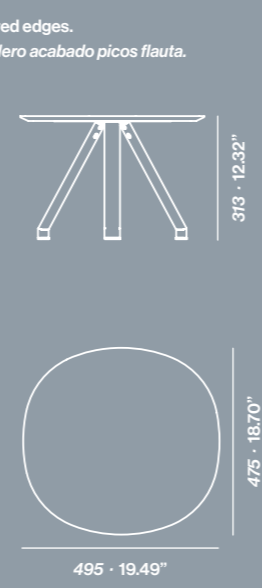

Mitred edges.  
Tablero acabado picos flauta.

mm · inches

Celes



**Different sizes and finishes.  
Combinable with each other.  
Indoor.**

*Diferentes tamaños y acabados.  
Combinables entre sí.  
Uso interior.*

**CELESPOM**

<sup>EN</sup> Optionally, an oak central handle can be added to the indoor Celes table for easy movement.

<sup>ES</sup> De forma opcional, se le puede añadir a la mesa Celes de interior un asa central de roble que ayuda a su desplazamiento.

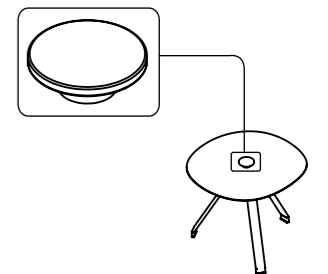

<sup>EN</sup> The tabletops of this collection are available in lacquered MDF or transparent tempered glass, and can be combined with two base versions.

<sup>ES</sup> Los sobres de esta colección de mesas están disponibles en MDF lacado o cristal templado transparente de 10mm de espesor que combinan con dos versiones de bases.

Mill by  
STC Studio

**Mill**



MIYC

Glass top and "Y" base.  
Sobre de cristal y base "Y".

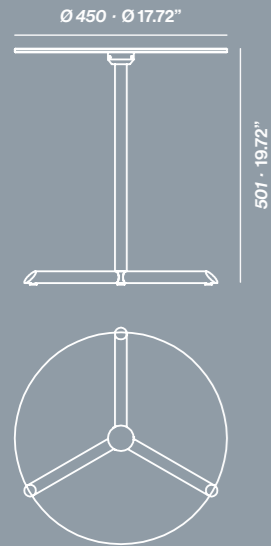

MIOC

Glass top and "O" base.  
Sobre de cristal y base "O".

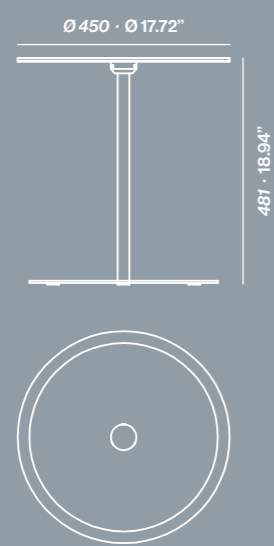

MIYM

Laquered MDF top and "Y" base.  
Sobre de MDF lacado y base "Y".

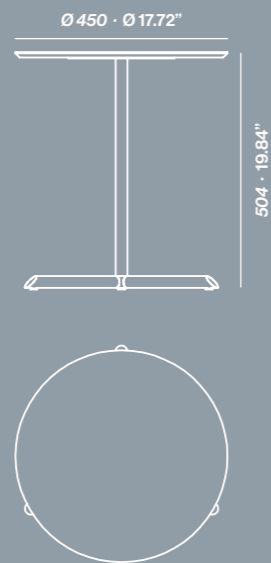

MIOM

Laquered MDF top and "O" base.  
Sobre de MDF lacado y base "O".

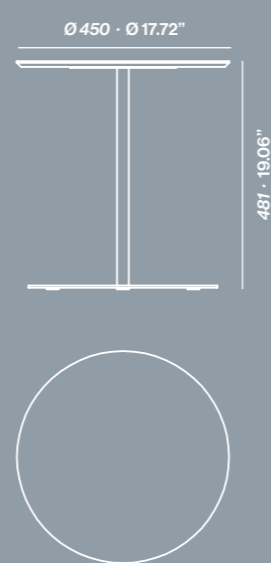

mm · inches

Mill



**Different tops, different base.  
You decide.**

*Diferentes sobres, diferentes bases. Tú decides.*

EN Laura is a versatile and functional table. This side table has so many possibilities as you can imagine. It has a container that can be used as a plant pot or store.

ES *Laura es una mesa versátil y funcional. Tiene tantas posibilidades como puedas imaginarte. Cuenta con un contenedor que puede servir de macetero o para guardar objetos.*

Laura by  
Mermelada Estudio

# Laura



LAURA

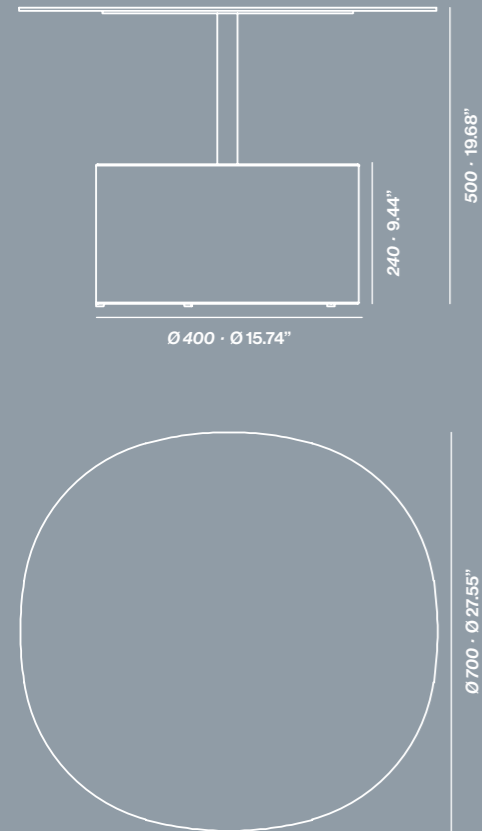

mm · inches

# Laura



**Versatile and multipurpose.**

*Versátil y polivalente.*

EN The forms of the Malva space divider emerge inspired by the waves of the sea, a place where you can switch-off and enjoy a moment of tranquility. The Malva is versatile and adaptable to a great variety of environments. Available in different colors and sizes.

ES *Las formas del separador de ambientes Malva surgen de la inspiración en las olas del mar, un lugar donde desconectar y buscar un momento de tranquilidad. El separador Malva es versátil y adaptable a una gran variedad de ambientes. Disponible en diferentes acabados y tamaños.*

Malva by  
Hugo Tejada

# Malva



MALVA\_H7

MALVA\_16

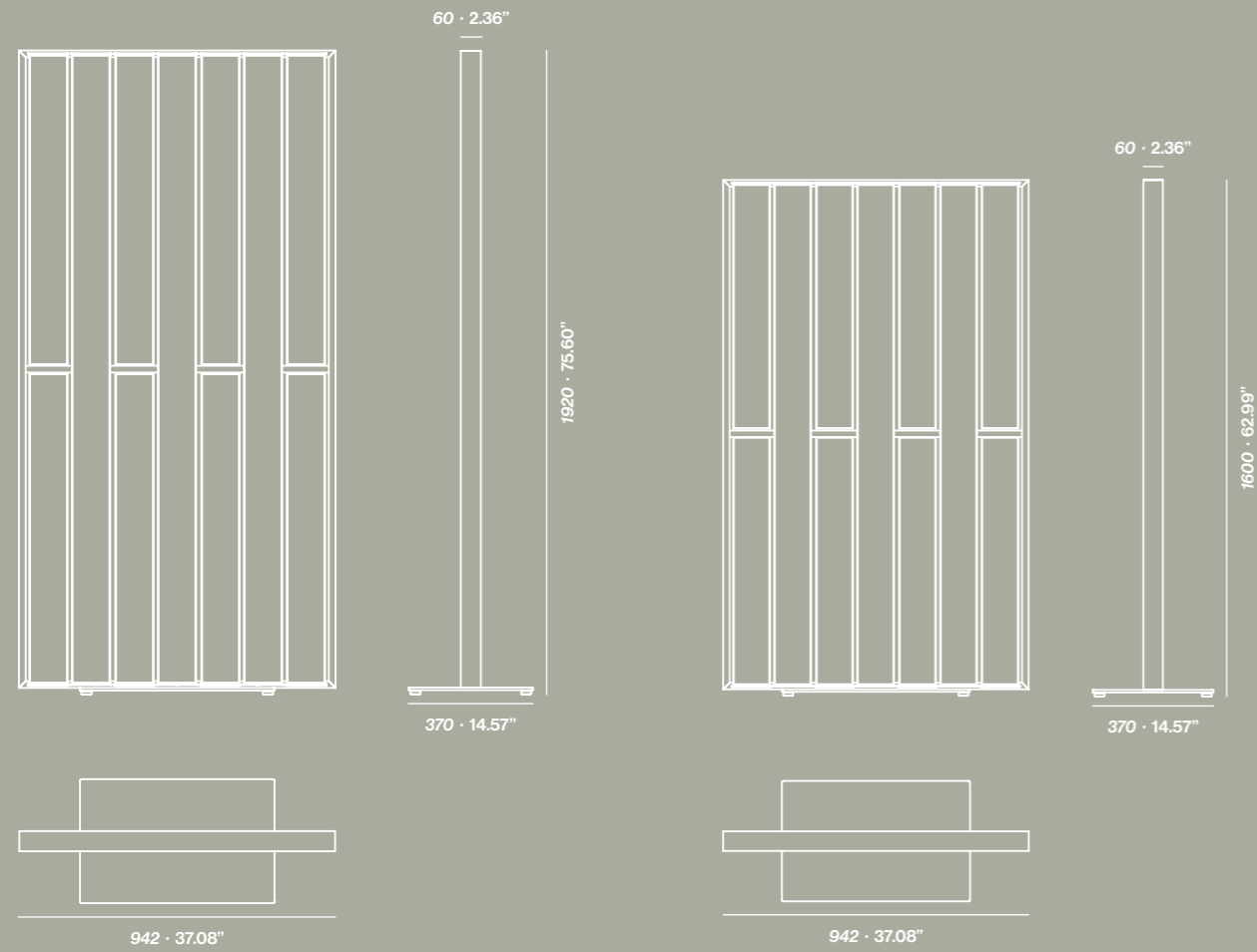

mm · inches

# Malva

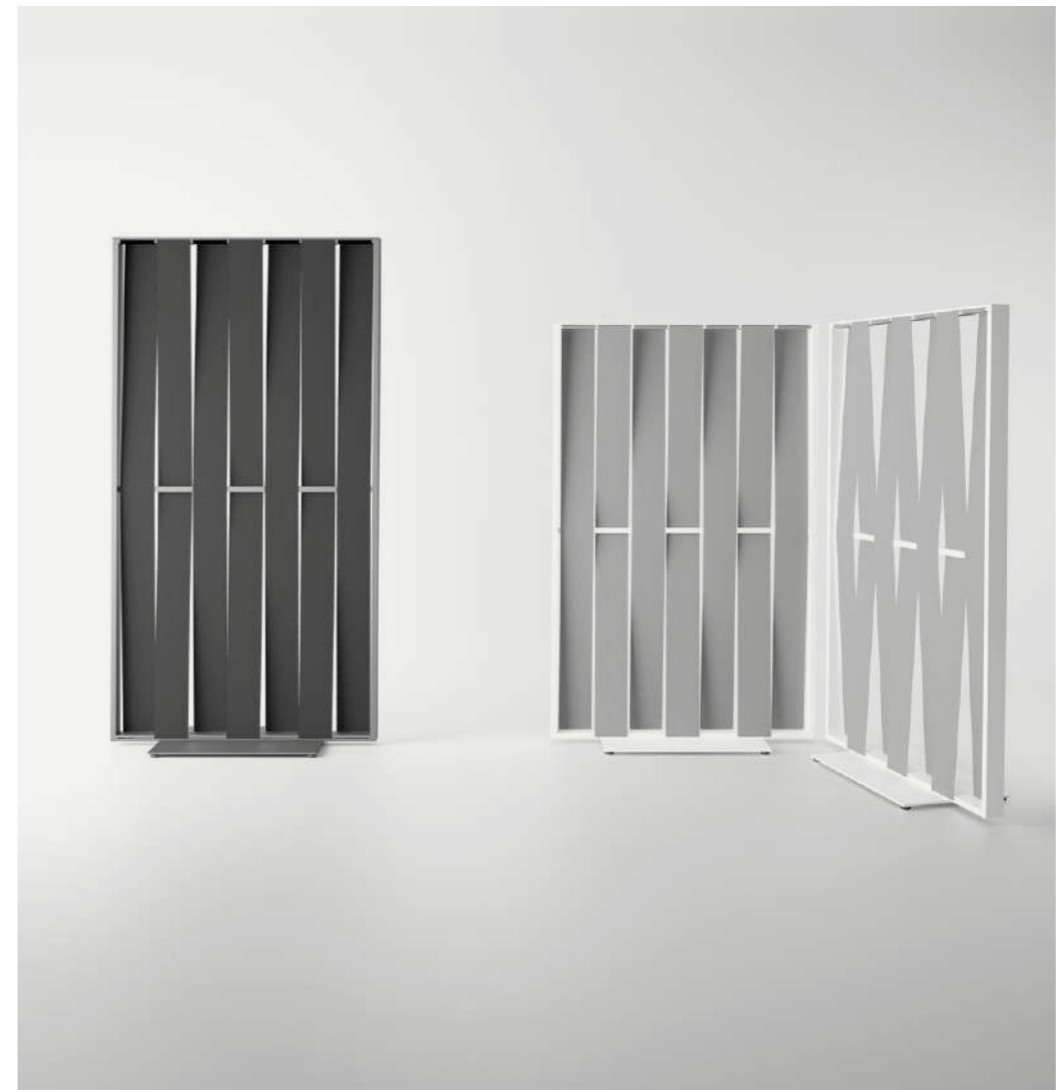

## Room divider. Turning single-use rooms into multiple spaces.

*Separador de espacios.  
Convertir habitaciones de un solo uso en espacios múltiples.*



<sup>EN</sup> Elegant and minimalist room divider with oak feet, composed by a rectangular structure of triangular section which frames and aluminum mesh. Available in different colors and sizes.

<sup>ES</sup> Elegante y minimalista separador de ambientes con pies de roble, compuesto por una estructura rectangular de sección triangular que enmarca una malla de aluminio. Disponible en diferentes colores y tamaños.

Parban by  
Victor Carrasco

# Parban





PARBAN\_L

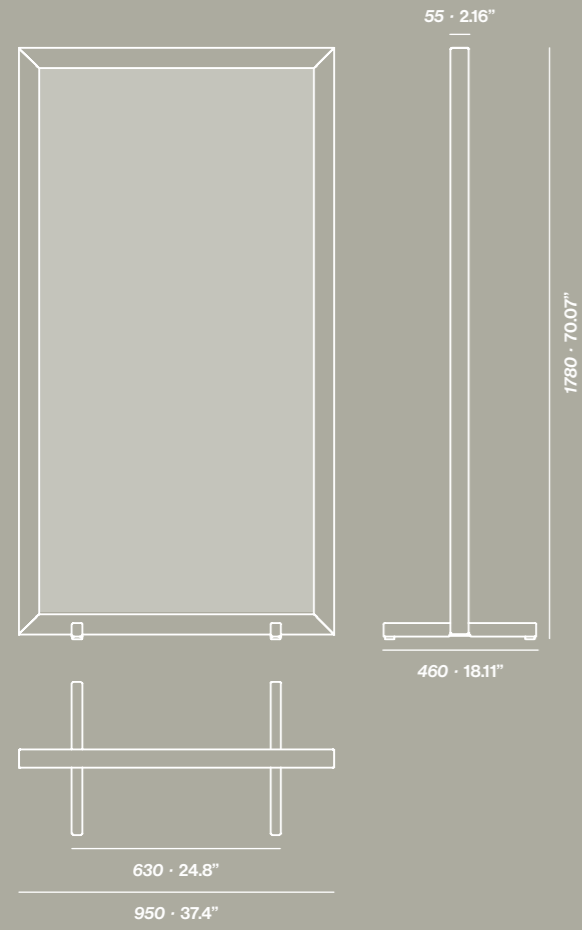

PARBAN\_S

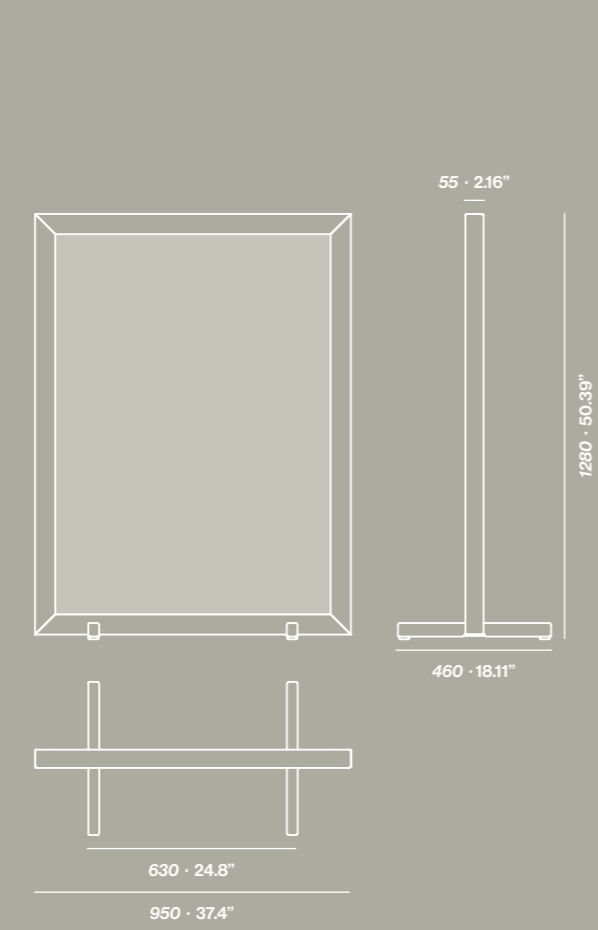

mm · inches

# Parban



## Who needs walls when you have Parban?

*¿Quién necesita muros cuando tienes Parban?*

EN The design of these planters evokes lamps that emit vegetation. Available in three versions: hanging, freestanding, and spike for ground insertion, each of them also available in three different sizes. Made of aluminum and steel.

ES El diseño de estos maceteros evoca lámparas que emiten vegetación. Disponibles en tres versiones: colgante, de pie y de punta para enterrar, cada uno de ellos a su vez disponibles en tres tamaños distintos. Fabricados en aluminio y acero.

Green Cloud by  
Mermelada Estudio

# Green Cloud







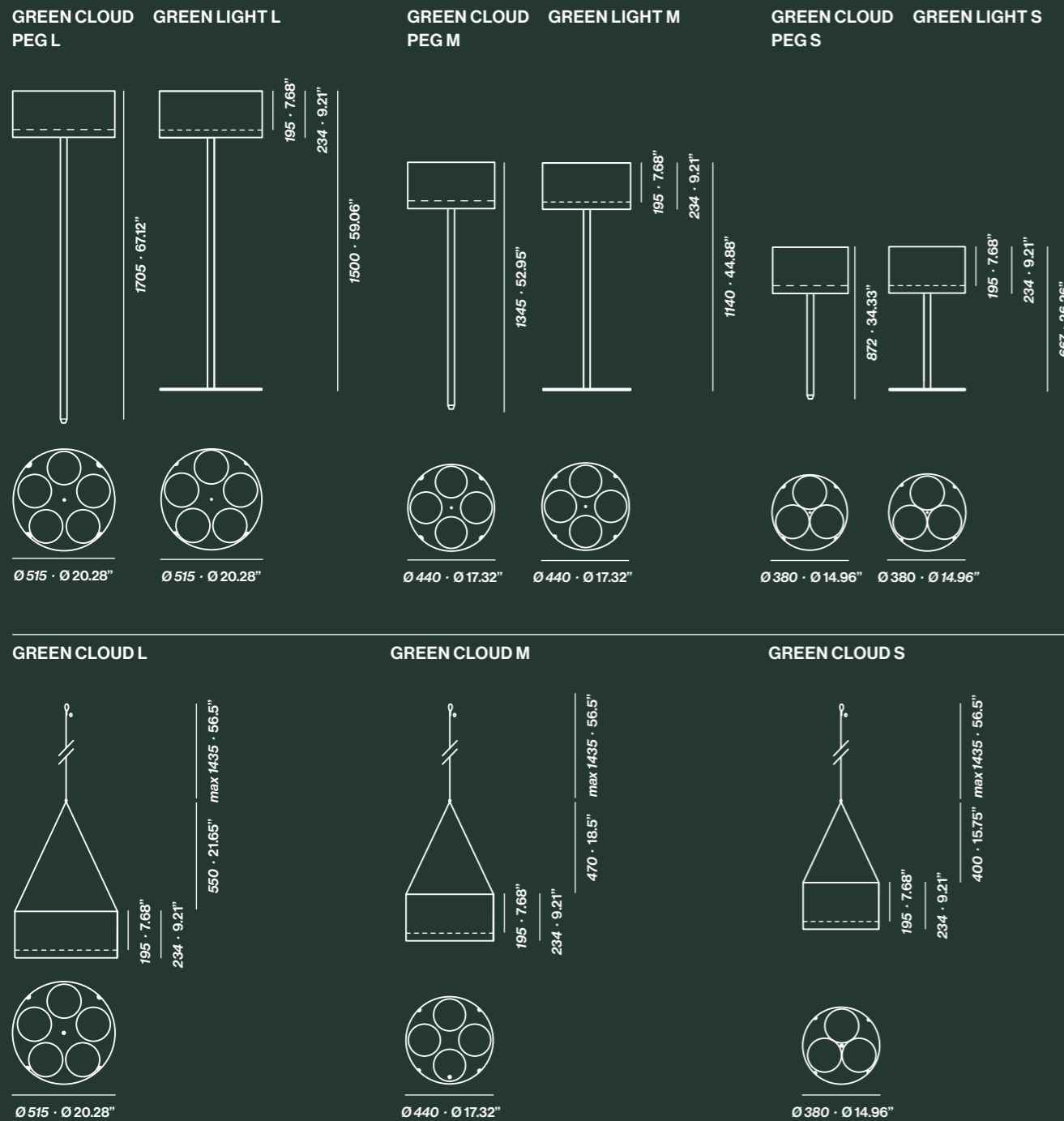

mm · inches

# Green Cloud



## Where nature and elegance go hand in hand.

*Donde naturaleza y elegancia se dan la mano.*

**EN** Do not add soil directly to the Green Cloud. Must be used with internal pots. The possibility of acquiring pots of 2,8 liters is offered, allowing combinations of 3, 4 or 5 depending on the capacity of the product.

**ES** No añadir la tierra directamente al Green Cloud. Debe usarse con macetas interiores. Se ofrece la posibilidad de adquirir macetas de 2,8 litros, para combinaciones de 3, 4 o 5 en dependencia de la capacidad del producto.

EN The design of these rectangular plant pots evokes lamp emitting vegetation. Three versions are available: hanging, desktop and wall-mounted. Manufactured in aluminum and steel.

ES El diseño de estos maceteros rectangulares evoca lámparas que emiten vegetación. Disponibles en tres versiones: colgante, sobremesa y a pared. Fabricados en aluminio y acero.

Green Light by  
Mermelada Estudio

# Green Light

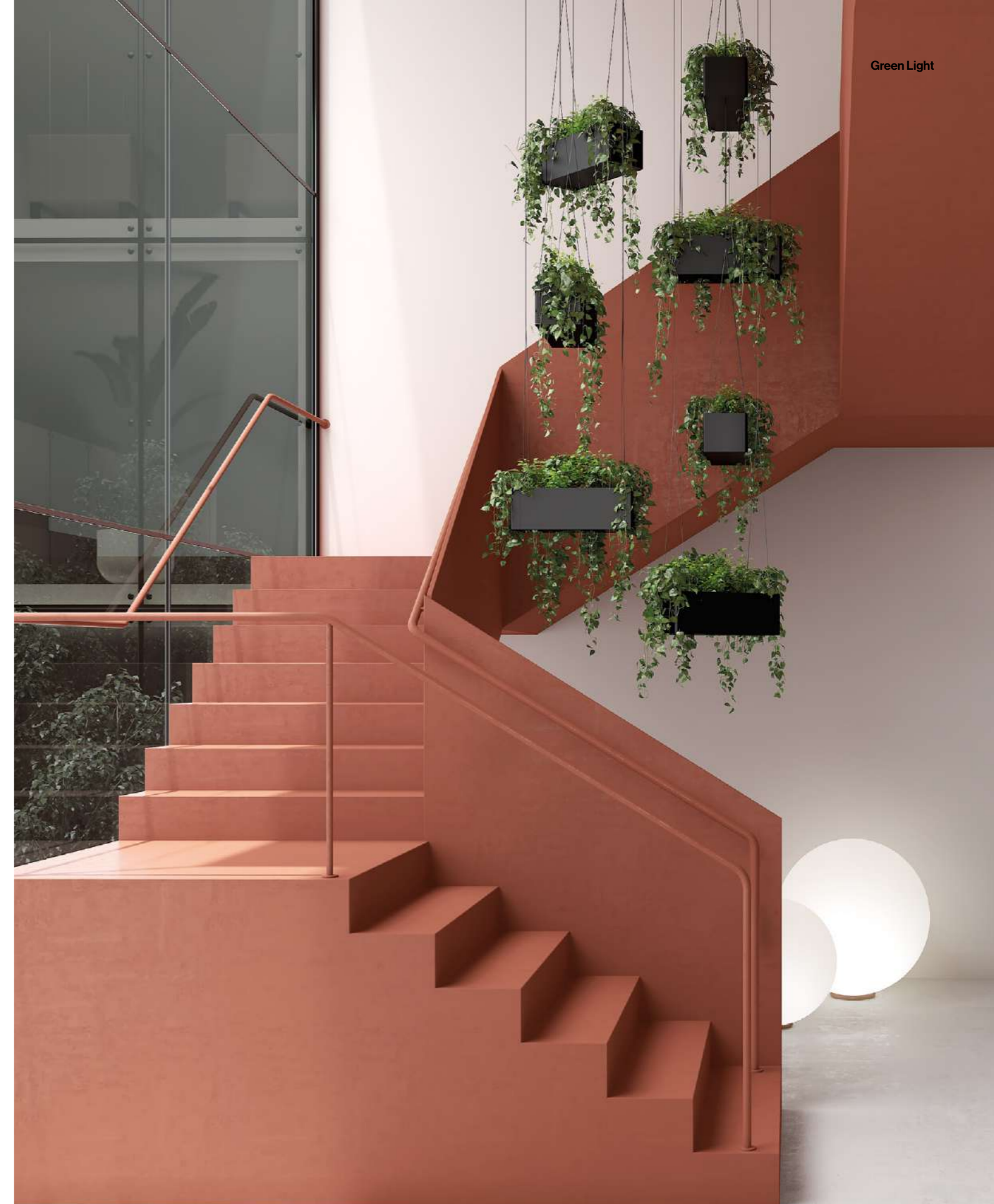





GREEN LIGHT\_C

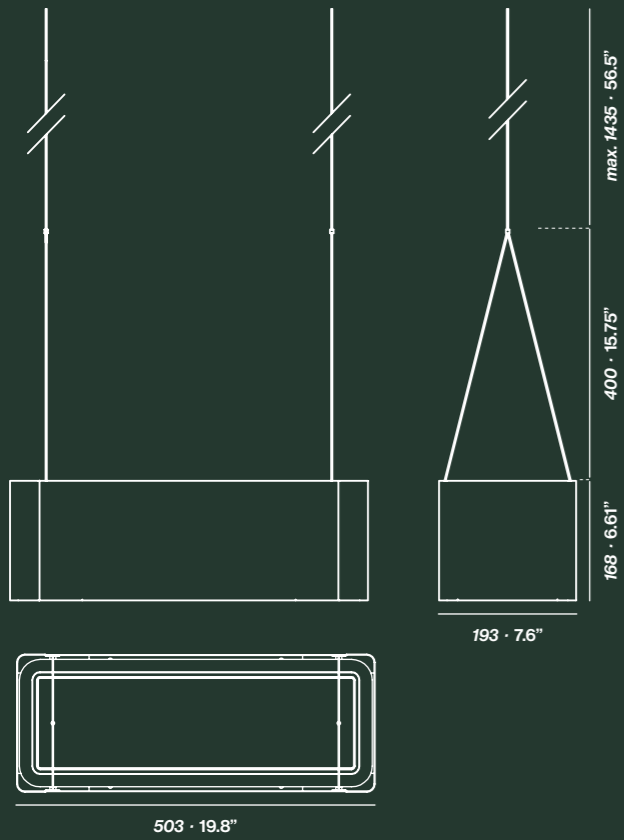

GREEN LIGHT\_P

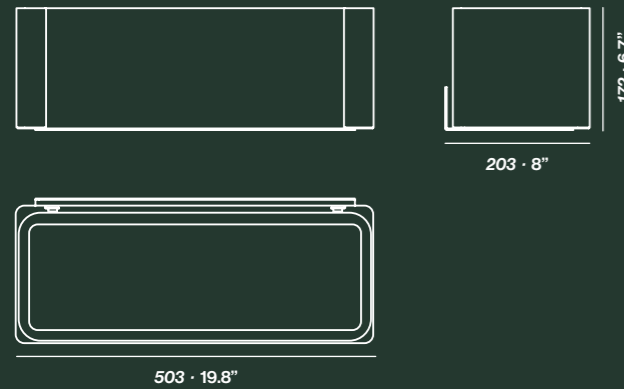

GREEN LIGHT\_T

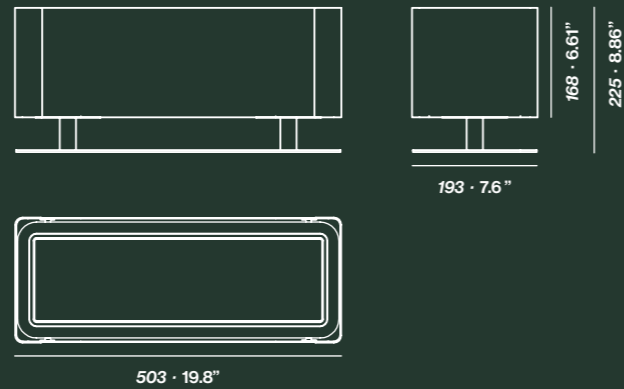

mm · inches

# Green Light



## Lightweight, durability, and elegance.

*Ligereza, durabilidad y elegancia.*

**EN Must be included:**  
1 saucer and 1 window box of 9 liters (19.69"x7.09"\_h5.91").  
The possibility of acquiring them is offered.

**ES Deben incluir:**  
1 plato y 1 maceta balconera de 9 litros (500x180\_h150mm).  
Se ofrece la posibilidad de adquirir estos productos.



**EN** All the Conee plant pots have a cone trunk structure with a bent axis, made of a curved aluminum sheet. They come with casters.

**ES** Todos los Conee jardinera poseen una estructura de tronco de cono con el eje inclinado, compuesta por una plancha curvada de aluminio. Lleva ruedas.

Conee Plant Pot by  
Victor Carrasco

# Conee Plant Pot



**CONEE\_L Plant Pot**

Plant pot 350L.  
Jardinera 350L.

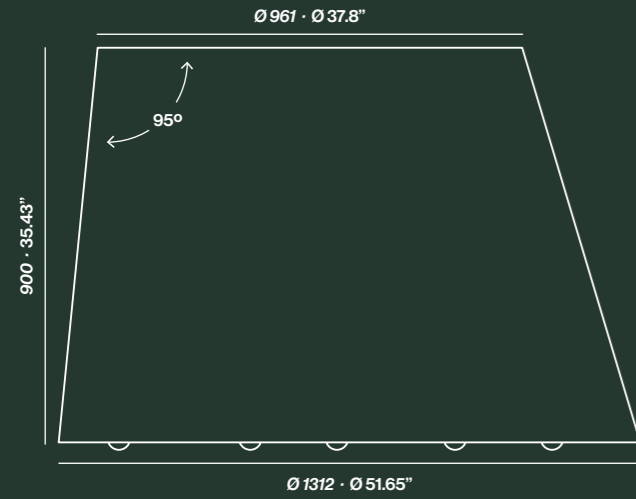

**CONEE\_M Plant Pot**

Plant pot 60L.  
Jardinera 60L.

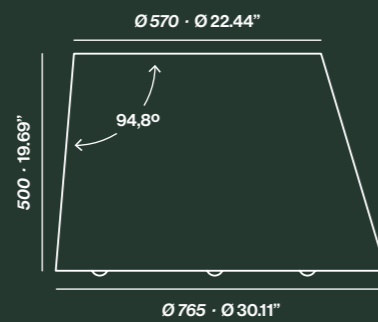

**CONEE\_S Plant Pot**

Plant pot 12L.  
Jardinera 12L.

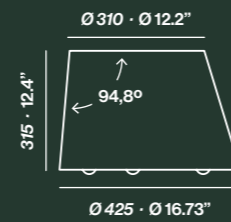

mm · inches

# Conee Plant Pot



## Nature-inspired. Your garden deserves Conee.

*Inspirado en la naturaleza.  
Tu jardín merece Conee.*

EN They include a saucer and an interior pot. ES Incluye plato y macetero interior.

Conee

# Socialize with comfort, socialize with poufs!

*¡Socializa con comodidad, socializa con pufs!*



Conee Pouf by  
Víctor Carrasco

CONEE\_P\_POUF

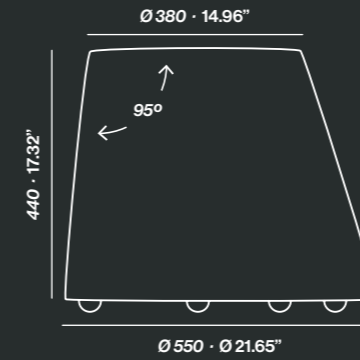

mm · inches

# Conee Pouf

**EN** The Conee pouf has a wooden cone trunk structure with a bent axis, and it's upholstered in faux leather. It comes with 5 casters.

**ES** El Conee puff posee una estructura de madera de tronco de cono con el eje inclinado, y va tapizado en polipiel. Lleva 5 ruedas.

Tenemos la solución.

# We have the solution.



systemtronic



01



02



03



04



05

**EN** The outdoor office is becoming a growing trend due to the numerous benefits it offers for both health and productivity. Working outdoors not only enhances the sense of well-being but also promotes creativity and concentration thanks to direct contact with nature.

At Systemtronic, we offer a wide range of furniture and accessories made from high-quality materials that ensure durability and resistance to exposure to the sun, rain, and other atmospheric agents.

Some of our products are equipped with wheels, making them easy to move and especially useful in dynamic environments where frequent space reconfiguration is necessary.

Additionally, many of them are part of product families that cover various utilities. This offers the advantage of creating a coherent and functional design while maintaining a uniform aesthetic. With Systemtronic, designing and decorating an outdoor workspace becomes a simple and rewarding task, always ensuring the highest quality and comfort for users.

**ES** La oficina outdoor se está convirtiendo en una tendencia creciente debido a los numerosos beneficios que aporta tanto para la salud como para la productividad. Trabajar al aire libre no solo aumenta la sensación de bienestar, sino que también fomenta la creatividad y la concentración gracias al contacto directo con la naturaleza.

Systemtronic cuenta con una amplia gama de muebles y accesorios fabricados con materiales de alta calidad que garantizan durabilidad y resistencia ante la exposición al sol, la lluvia y otros agentes atmosféricos.

Algunos de los productos están equipados con ruedas, lo que facilita su desplazamiento y es especialmente útil en entornos dinámicos donde la reconfiguración frecuente del espacio es necesaria.

Además, muchos de ellos forman parte de familias que abarcan diversas utilidades. Esto ofrece la ventaja de poder crear un diseño coherente y funcional, manteniendo una estética uniforme.

Tenemos la solución.

# We have the solution.

## Shop the look Compra el conjunto

01 DROP TOP - Paper bins 02 FLORA - Vase lamps 03 CREPE - Plant pots 04 CELES - Side tables 05 CREPE - Umbrella stand & plant pot



**EN** Paper bins of different capacities, made of galvanized steel and coated with oven thermoset powder paint. They include an inner galvanized steel ring that holds the bag in an elegant and practical way. As a novelty, the Drop family adds a new model with a lid: the 29-litre Drop Top.

**ES** *Papeleras de distintas capacidades, fabricadas en acero galvanizado y pintadas con pintura en polvo termoendurecida lacada al horno. Incluyen un aro interior de acero galvanizado que sujeta la bolsa de forma elegante y práctica. Como novedad, la familia Drop añade un nuevo modelo con tapa: la Drop Top de 29 litros.*

Drop by  
STC Studio

# Drop





DROP\_29 liters · litros

DROP TOP\_29 liters · litros

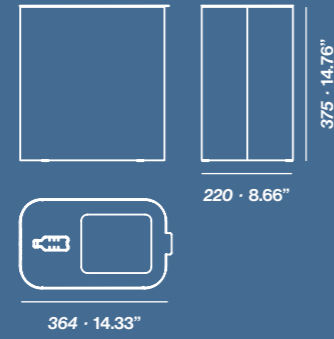
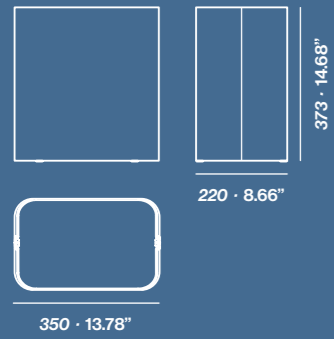

DROPOL\_36 liters · litros

DROPOR 25+7 liters · litros

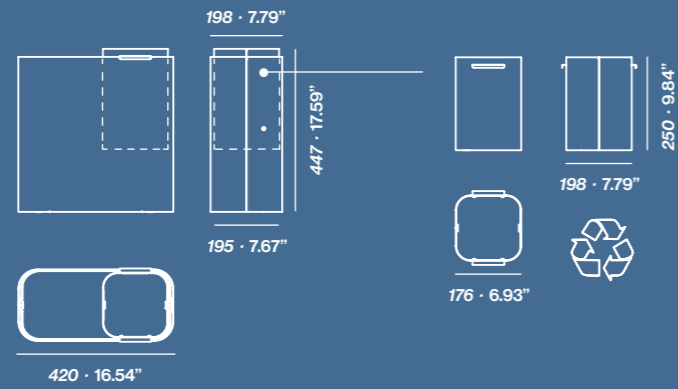
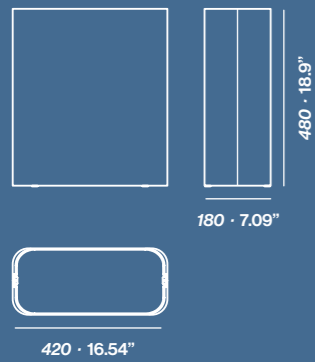

mm · inches

Drop



Keep it elegant.

Mantenlo elegante.

-  glass
-  organic
-  paper
-  plastic
-  generic
-  aluminum

## Pictogram

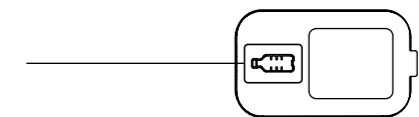

## Drop Mini

# Mini, but with a soul of steel.

*Mini pero con alma de acero.*



Drop Mini by  
STC Studio

DROP MINI\_13 liters · litros

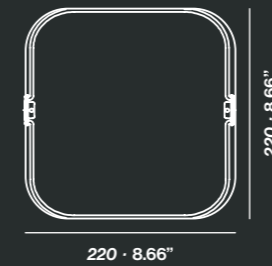

DROP TOP MINI\_13 liters · litros

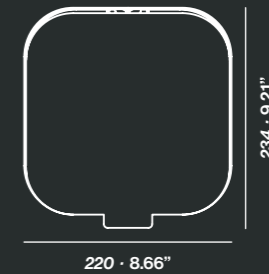
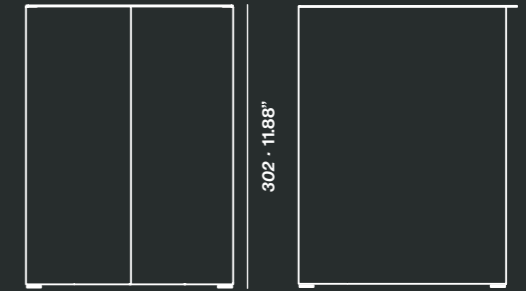

**EN** 13 liter bin. Made of galvanized steel and coated with oven thermoset powder paint. Like all the bin of its series, it includes a galvanized steel inner ring that holds the bag.  
The use of 10 liter garbage bags is recommended.

**ES** Papelera con capacidad de 13 litros. Fabricada en acero galvanizado y pintada con pintura en polvo termoendurecida lacada al horno. Como todas las papeleras de su serie, incluye un aro interior de acero galvanizado que sujeta la bolsa.  
Se recomienda el uso de bolsas de basura de 10 litros.

mm · inches

# Drop mini



**EN** The Drop Top paper bin partially conceals waste. It is identified with a vinyl pictogram for sorting, allowing combinations of two or more bins.

Manufactured in galvanized steel and painted with powder-coated thermosetting paint baked in the oven. It includes an inner ring of galvanized steel that holds the bag. Its capacity is 62 liters. The use of 50-liter bags or larger is recommended. The option of using an aluminum lid without holes for outdoor use is available.

**ES** La papelera con tapa Drop Top oculta parcialmente los residuos. Se identifica con un pictograma vinílico para su clasificación, de manera que puedan realizarse combinaciones de dos o más papeleras.

Fabricadas en acero galvanizado y pintado con pintura en polvo termoendurecida lacada al horno. Incluye un aro interior de acero galvanizado que sujeta la bolsa. Su capacidad es de 62 litros. Se recomienda el uso de bolsas de 50 litros o más. Se ofrece la posibilidad de usar una tapa de aluminio sin agujeros para el uso en exteriores.

# Drop Top

DROP TOP\_62 liters · litros

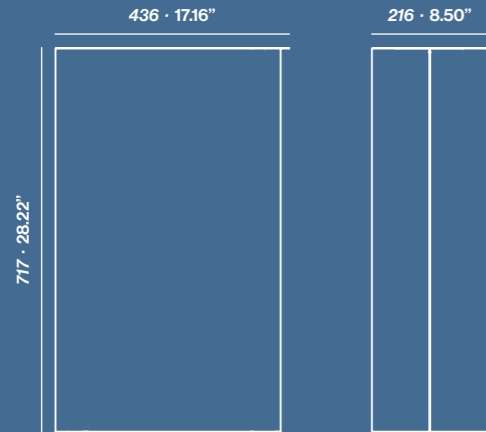

-  glass
-  organic
-  paper
-  plastic
-  generic
-  aluminum

## Pictogram



mm · inches

# Drop Top

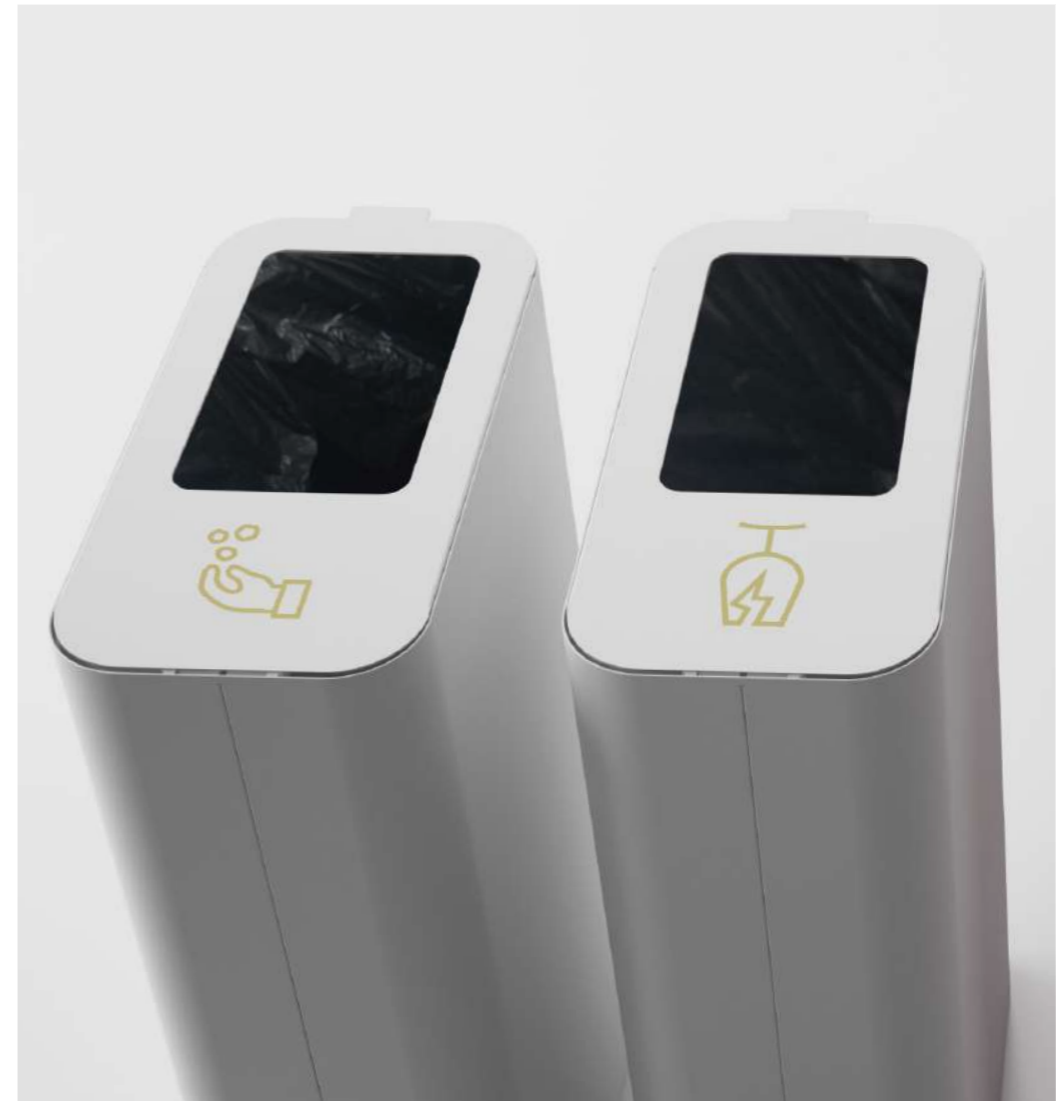

## Built for a better tomorrow.

*Construidas para un mañana mejor.*

**EN** The Drop Top Triple bin allows for multiple recycling within a single container thanks to its geometric shape with three distinct compartments in the lid. The three cavities are identified with a vinyl pictogram.

Manufactured in galvanized steel and painted with powder-coated thermosetting paint baked in the oven. It includes three inner rings of galvanized steel that hold the bags.

Its capacity is 120 liters. The use of 50-liter bags or larger is recommended. The option of using an aluminum lid without holes for outdoor use is available.

**ES** La papelera con tapa Drop Top Triple permite el reciclaje múltiple en un único contenedor gracias a su forma geométrica con tres compartimentos diferenciados en la tapa. Las tres cavidades se identifican con un pictograma vinílico.

Fabricada en acero galvanizado y pintado con pintura en polvo termoendurecida lacada al horno. Incluye tres aros interiores de acero galvanizado que sujetan las bolsas.

Su capacidad es de 120 litros. Se recomienda el uso de bolsas de 50 litros o más. Se ofrece la posibilidad de usar una tapa de aluminio sin agujeros para el uso en exteriores.

Drop Top Triple by  
STC Studio

# Drop Top Triple

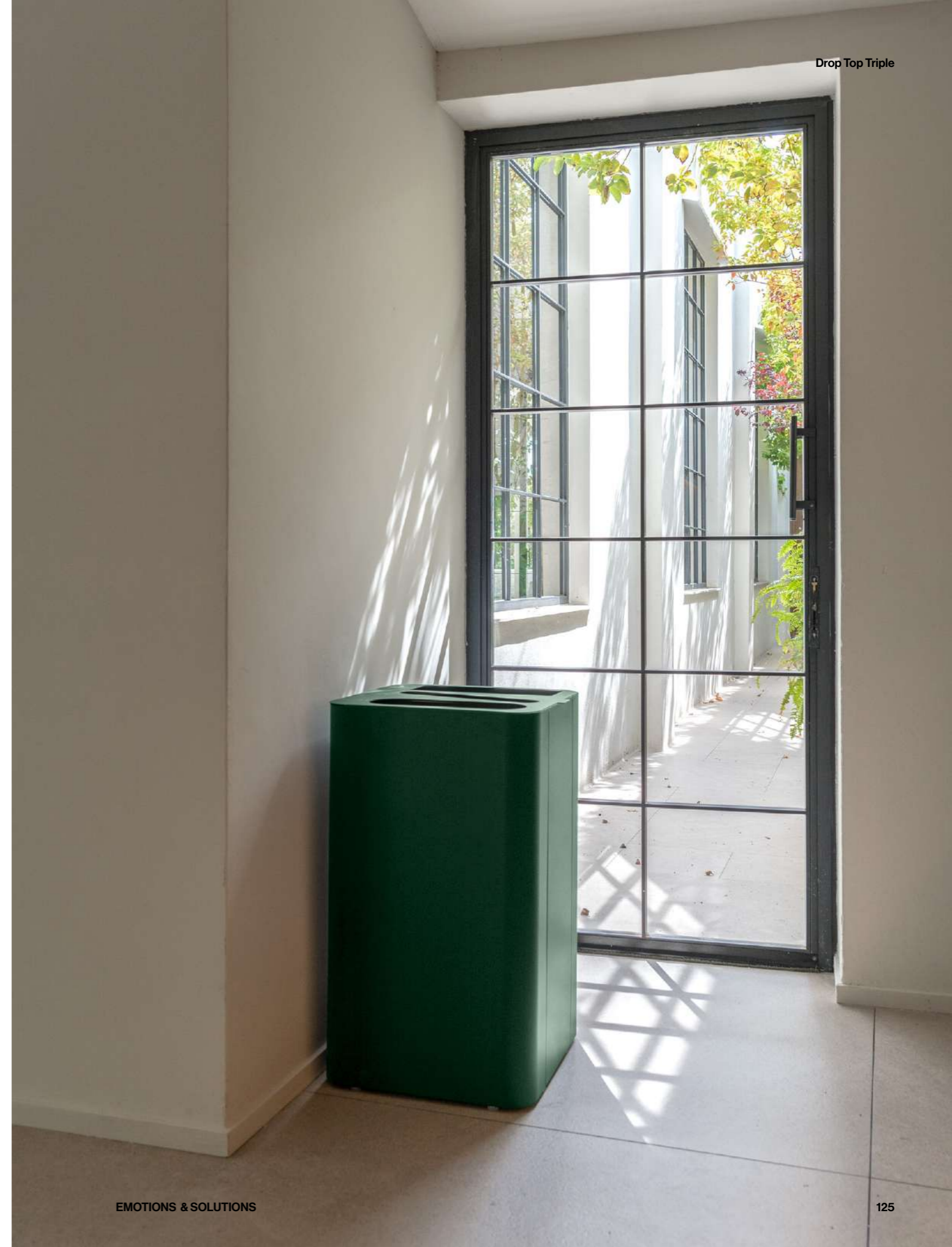





DROP TOP TRIPLE

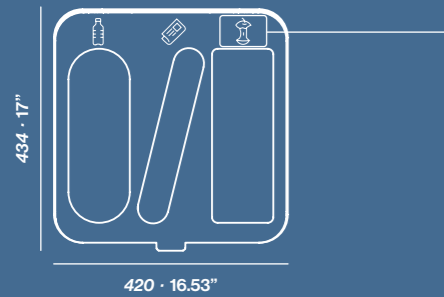
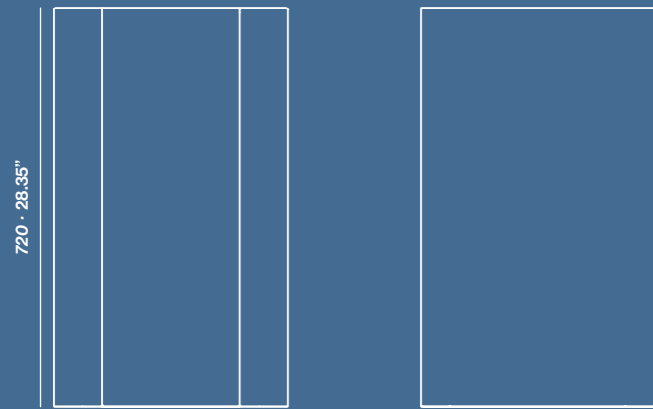

-  glass
-  organic
-  paper
-  plastic
-  generic
-  aluminum

# Pictogram

mm · inches

# Drop Top Triple



## Multiple recycling. Three identifiable compartments.

*Reciclaje múltiple.  
Tres compartimentos identificables.*

<sup>EN</sup> Singular umbrella stand made of galvanized steel sheet with two separate buckets, one for long umbrellas and another bucket for folding ones. The colors of both can be combined.

<sup>ES</sup> Original paraguero de plancha de acero galvanizado con dos cubetas independientes, una destinada a los paraguas largos y otra cubeta para los plegables. Se pueden combinar los colores de ambas.

# Drop Out



DROT

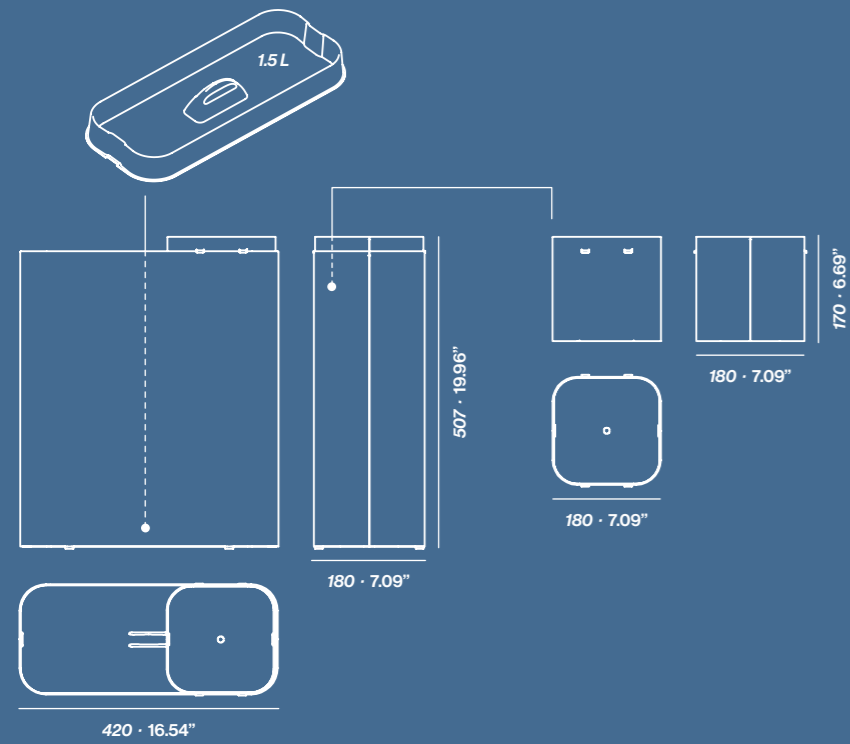

DROTOL

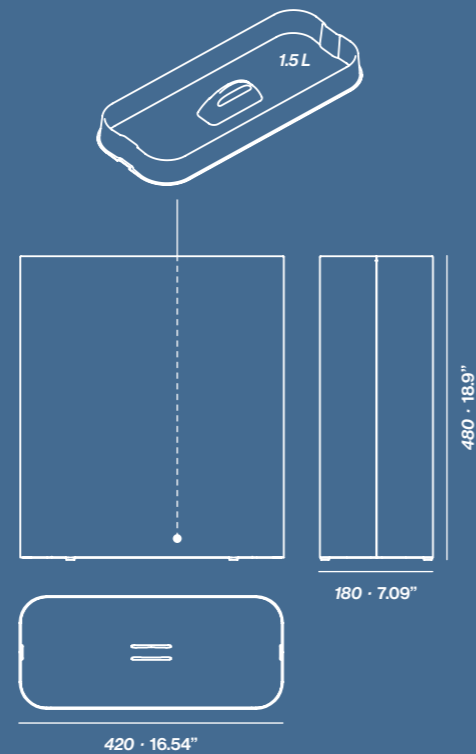

mm · inches

# Drop Out



**Choose your color combination.  
It doesn't matter the size of the umbrella;  
it has two buckets.**

*Elige tu combinación de colores.  
No importa el tamaño del paraguas; tiene dos cubos.*



**EN** Umbrella stand composed by three painted steel panels, thought-out for either big or small umbrellas. Two versions are available: standing or on the wall. The base and the middle panel can be painted in a second color. It has interior cups made of aluminum for water collection.

**ES** *Paragüero compuesto por 3 paneles de acero pintados, pensado para paraguas tanto grandes como pequeños. Dos versiones disponibles: de pie y a pared. El acabado puede personalizarse pintando la base y el panel intermedio de un segundo color. Dispone de cazoletas interiores fabricadas en aluminio para la recogida de agua.*

Sou by  
Tomoya Tabuchi

# Sou

SOU\_STAND

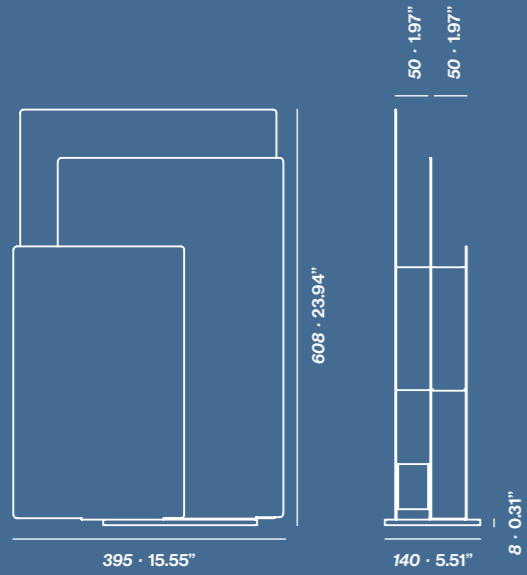

SOU\_WALL

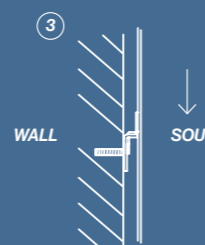
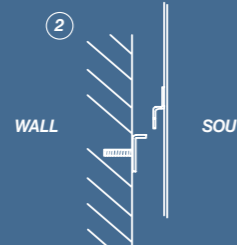
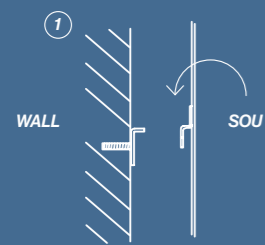
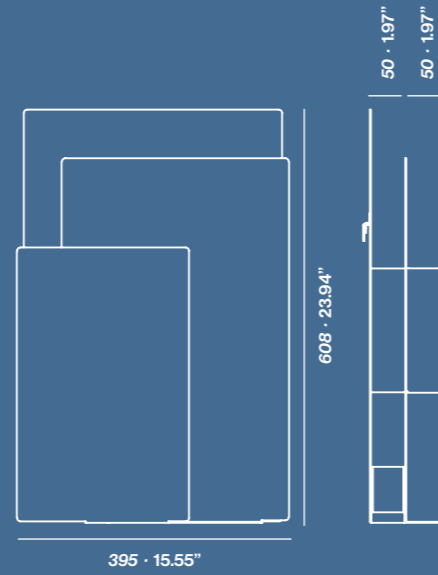

mm · inches

Sou



**Two models:  
Freestanding or wall-mounted.  
There is no bad weather when  
there is good design!**

*Dos modelos: autoportante o de pared.  
¡No hay mal tiempo cuando hay buen diseño!*

<sup>EN</sup> Minimalist umbrella stand made of zinc-plated steel sheet of 2mm folded into a "U". The polyethylene base makes it dry easily.

<sup>ES</sup> *Paragüero minimalista fabricado en plancha de acero cincado de 2mm plegada en forma de "U". Su base de polietileno permite un fácil secado.*

Forrein by  
STC Studio

# Forrein



FORREIN

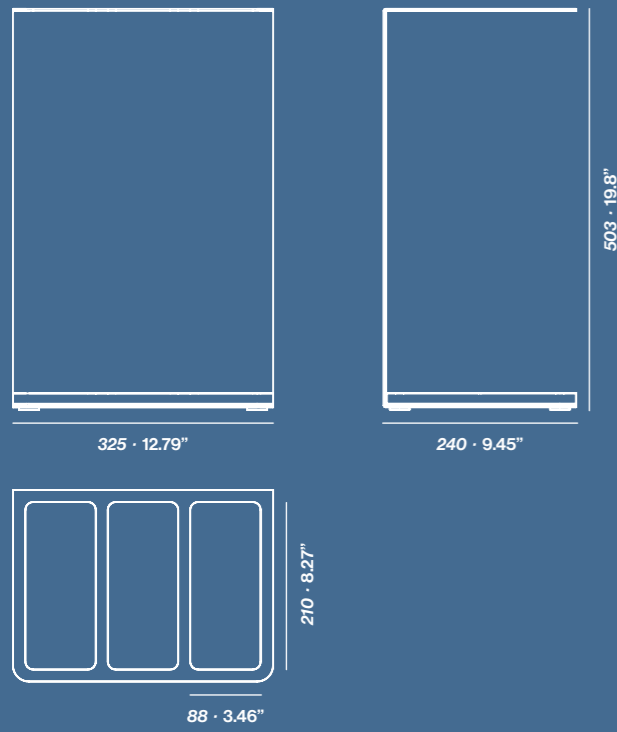

mm · inches

# Forrein



## Easy to dry.

*Fácil de secar.*

**EN** Screen in the Air (SITA) is a versatile support for televisions and monitors, suitable for homes, common areas and meeting rooms. It stands out for its elegant back which hides electrical connections providing an impeccable image.

Mounting interface standard VESA 75, 100, 200, 300 and 400, with possibility of VESA accessory for 600 and 800. The monitor can rotate 240°.

Its casters allows its movement.

SITABO box container available.

Produced in steel.

**ES** *Screen In the Air (SITA) es un soporte para televisiones y monitores versátil e idóneo para hogares, zonas comunes y salas de reuniones. Destaca por su elegante trasera que oculta las conexiones eléctricas proporcionando una imagen cuidada.*

*Interface de montaje standar VESA 75, 100, 200, 300 y 400 con posibilidad de accesorio VESA para 600 y 800.*

*El monitor se puede girar 240°.*

*Dispone de ruedas para poder moverlo.*

*Disponible cajón contenedor SITABO.*

*Fabricado en acero.*

Sita by  
STC Studio

# Sita







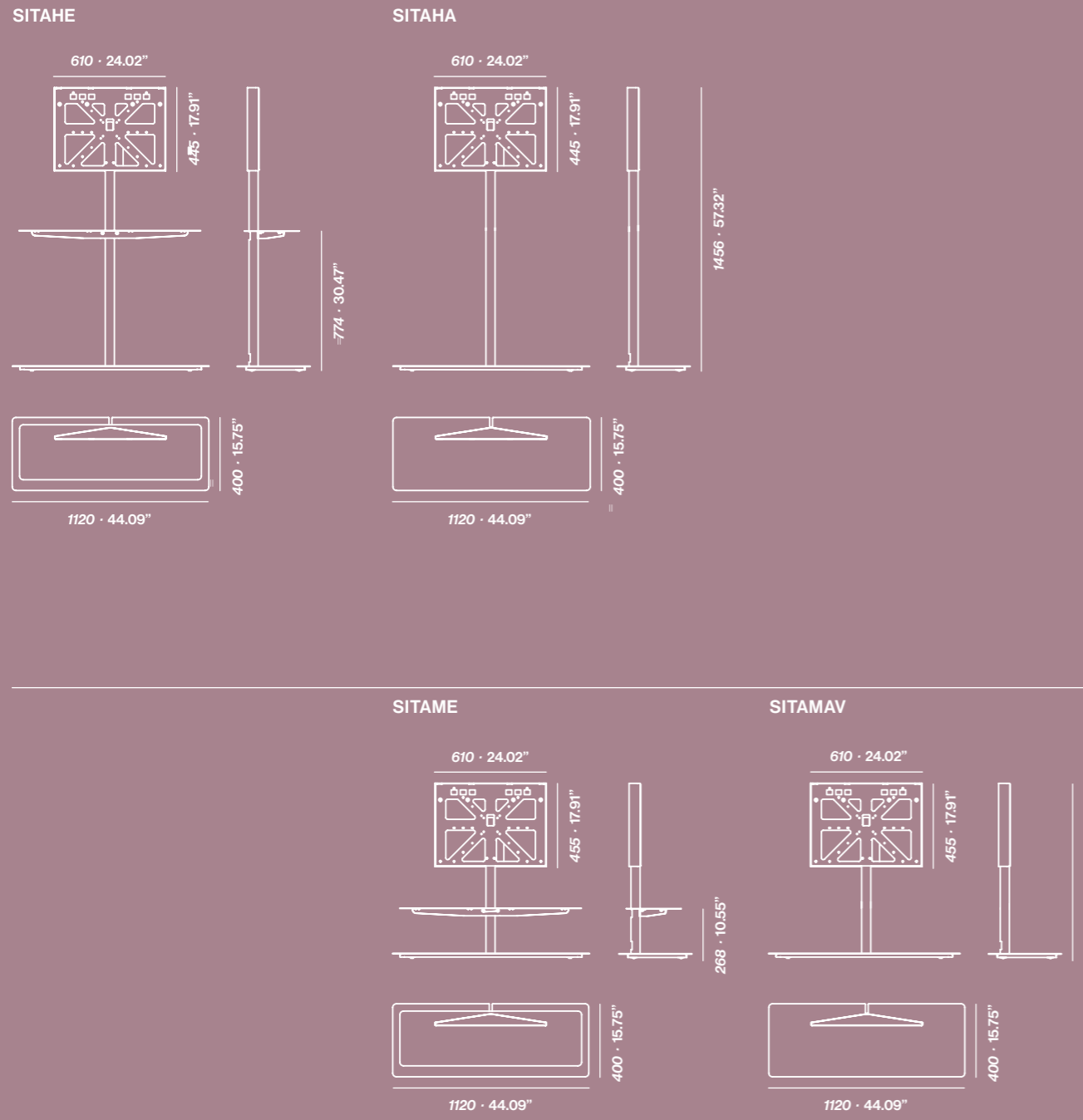

mm · inches

Sita



## Screen in the air. Multiple rotations.

*Pantalla suspendida.  
Múltiples rotaciones.*

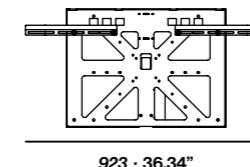
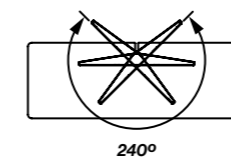

Accesorio for VESA 600 or 800  
Accesorio para VESA 600 o 800

Sitave



EN Its design includes 4 small casters which facilitate forward and backward movement.

ES El diseño incluye 4 pequeñas ruedas que facilitan su desplazamiento hacia delante y hacia detrás.



EN Rotary movement of the set can be obtained equipping the optional wheel kit.

ES Para un movimiento rotatorio de SITA se ofertan otras ruedas.

**EN** Elegant module container for the multimedia equipment. The design contains a fixed magnetic back cover which gives an easy access. The furniture disposes of two openings: one at the base for the cable guide, and another at the cover for the ventilation of the equipment.

**ES** Elegante módulo contenedor para incluir los equipos multimedia. El diseño contiene una tapa trasera de fijación magnética que facilita el acceso. El mueble dispone de dos aberturas, una en la base para el guiado de los cables y otra en la tapa para procurar la ventilación de los equipos.



Sitabo by  
STC Studio

## Sitabo

¡Una solución elegante para tu equipo multimedia!

# An elegant solution for your multimedia equipment!

### SITABO



500 · 19.69"

400 · 15.75"

It includes 4 small casters.  
Incluye 4 ruedas pequeñas.

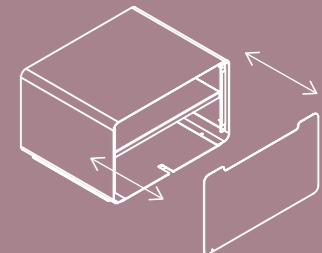
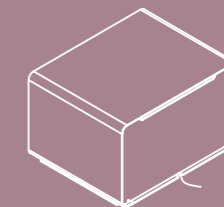
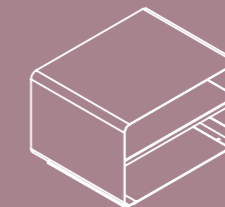

### Movement · Desplazamiento

**EN** Its design includes 4 small casters which facilitate forward and backward movement.

**ES** El diseño incluye 4 pequeñas ruedas que facilitan su desplazamiento hacia delante y hacia atrás.

mm · inches

## Sitabo

*¡No lo pienses, di que sí!*

# Dont think, say yes!

CANTINA

# systemtronic



**EN** The design of a cafeteria, especially within workspaces, should focus on creating a cozy, functional, and versatile environment that promotes social interaction, relaxation, and collaboration among employees.

Well-distributed recycling bins not only help keep the space clean but also encourage eco-friendly practices among employees. Incorporating natural plants improves air quality and adds a touch of nature, creating a more relaxing atmosphere. TV stands and interactive screens can be used for entertainment during breaks as well as for informal presentations or corporate announcements.

In this regard, Systemtronic offers a wide range of products ideal for cafeteria spaces, including recycling bins, side tables, shelves, TV stands, and benches. These products are perfect for current trends that value playful and flexible spaces.

**ES** El diseño de una cantina, especialmente dentro de espacios de trabajo, debe centrarse en crear un ambiente acogedor, funcional y versátil donde se fomente la interacción social, la relajación y la colaboración entre los empleados.

Las papeleras de reciclaje bien distribuidas no solo ayudan a mantener el espacio limpio, sino que también promueven prácticas ecológicas entre los empleados. Mediante la incorporación de plantas naturales se mejora la calidad del aire y se añade un toque de naturaleza, creando un ambiente más relajante. Soportes de televisión y pantallas interactivas pueden ser utilizados tanto para entretenimiento durante los descansos como para presentaciones informales o anuncios corporativos.

En este sentido, Systemtronic cuenta con una amplia gama de productos ideales para espacios de cantina. Estos productos son perfectos para las tendencias actuales que valoran los espacios lúdicos y flexibles.



No lo pienses, di que sí!

# Dont think, say yes!

## Shop the look *Compra el conjunto*

01 CREPE - Plant pots 02 BEN - Trolley 03 NANAME - Coat racks 04 GREEN CLOUD - Hanging planters 05 SITA - TV stand 06 DROP TOP TRIPLE - Paper bins 07 FAYA - Fire extinguisher support 08 DINA - Tables 09 KOKU - Bookshelves 10 ELICA MINI - Coat racks 11 CELES - Side tables

# Nube

## Your time, your schedule, your style!

*¡Tu tiempo, tu horario, tu estilo!*



Nube by  
Víctor Carrasco

### NUBE34

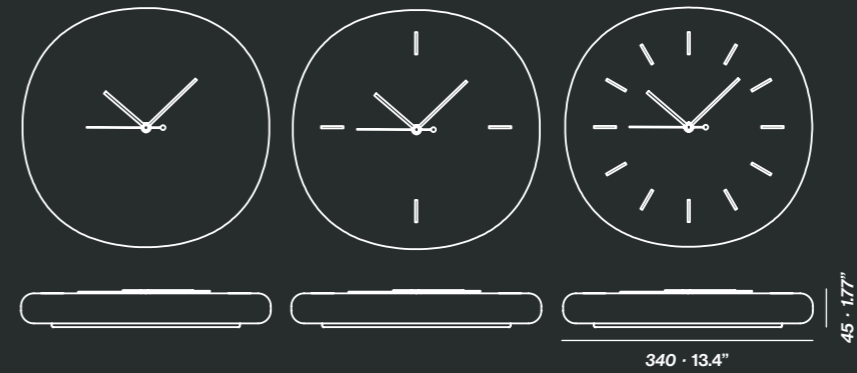

### NUBE48

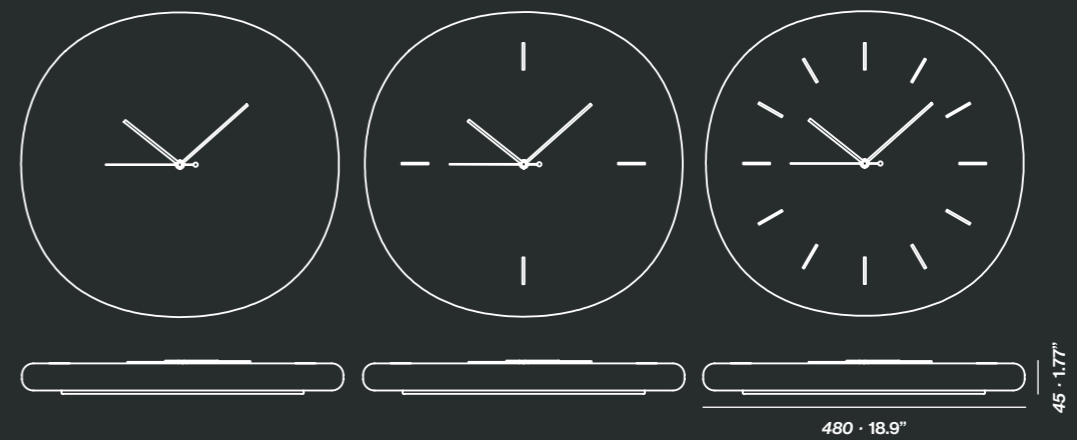

mm · inches

# Nube

EN Irregular circular shaped clock.  
Produced in lacquered MDF in different colors, or solid oak.  
Available in two sizes.

ES Reloj de pared de forma circular irregular.  
Fabricado en MDF lacado en diferentes colores o en roble macizo. Disponible en dos tamaños.

EN Modular shelves of linear aesthetics in vertical and horizontal disposition, that allow multiple compositions to suit the needs of each space. Produced in aluminum.

ES Baldas modulares de estética lineal en disposición vertical y horizontal, que permiten múltiples composiciones para adaptarse a las necesidades de cada espacio. Fabricadas en aluminio.

Baldas by  
Victor Carrasco

## Baldas

*La creatividad no tiene límites; este producto tampoco.*

**Creativity has no limits;  
this product either.**



BALDA\_S

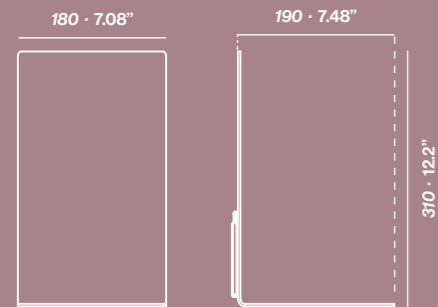

BALDA\_R

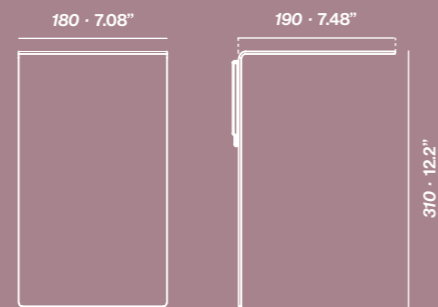

BALDA\_M



mm · inches

# Baldas



**Modular.**  
**Many combinations.**

*Modular.*  
*Muchas combinaciones.*



EN Usio shelving collection stands out for its clean and elegant line in all versions, perfect for small spaces. Bookcase formed by an aluminum column, with an anodized silver matt finish and painted steel shelves.

ES La colección de estanterías Usio destaca por su línea limpia y elegante en todas sus versiones, perfecta para espacios reducidos.

Librería con columna de aluminio, anodizado plata mate y estantes de acero pintados.

Usio by  
STC Studio

Usio



USP

USP single wall hanged.  
*Sencilla a pared.*

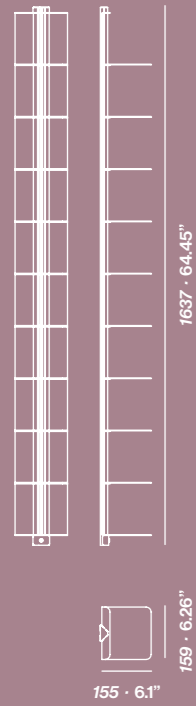

USB

USB single with base.  
*Sencilla con base.*

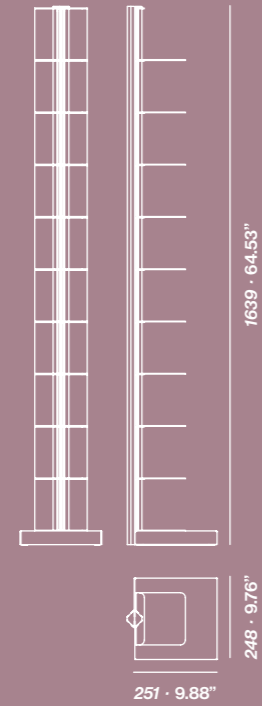

UDB

UDB double with base.  
*Doble con base.*

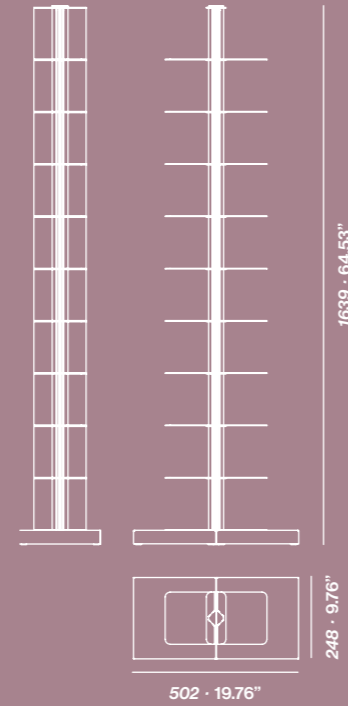

ZOOM

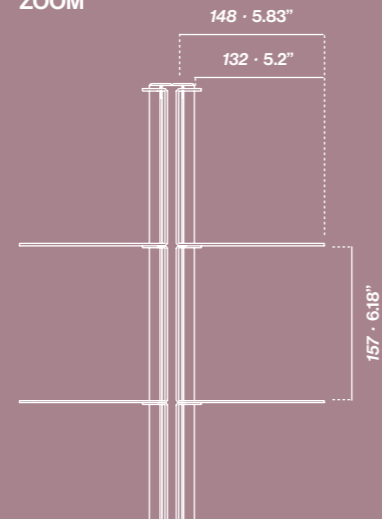

mm · inches

Usio



**Book tower.**  
**Put your wisdom in order.**

*Torre de libros.*  
*Pon orden a tu sabiduría.*

**EN** Singular shelves designed for your books or magazines, to cover space and functionality requirements. Manufactured in painted steel sheet with a simple wall-mounted system.

**ES** Estantes originales para tus libros o revistas, concebidos para cubrir necesidades de espacio y funcionalidad. Fabricado en plancha de acero pintado, con un sencillo sistema de fijación a pared.

Koku by  
Hugo Tejada

# Koku



KOKU

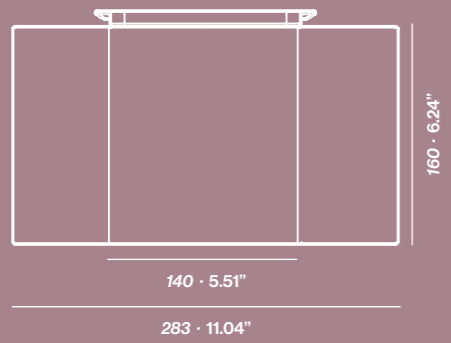

mm · inches

Koku

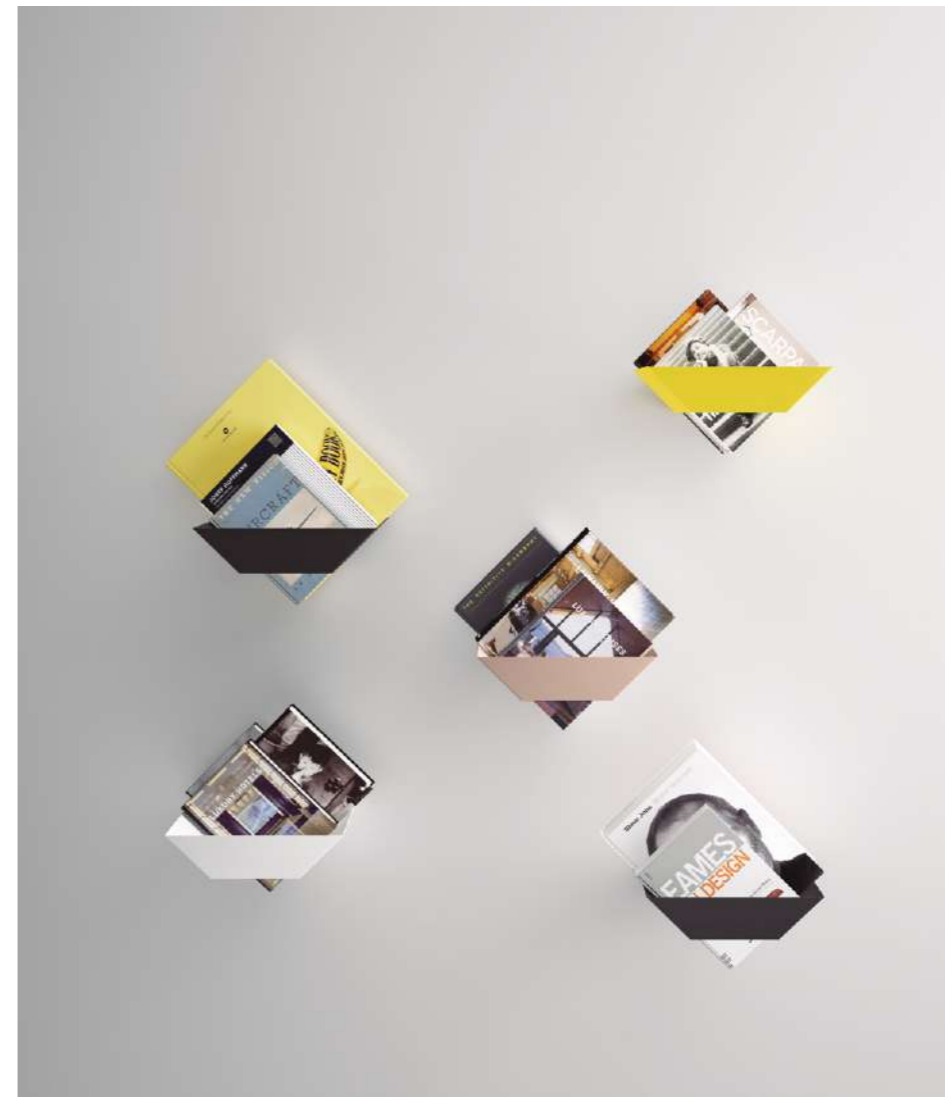

**Display your books.**

*Exhibe tus libros.*

**EN** Magazine rack inspired by architectonic shapes.  
Made of steel sheet and coated with oven thermoset powder paint.

**ES** *Revistero inspirado en formas arquitectónicas.*  
*Fabricado en plancha de acero y recubierto con pintura en polvo termoendurecida al horno.*

Mott by  
STC Studio

# Mott



MOTT

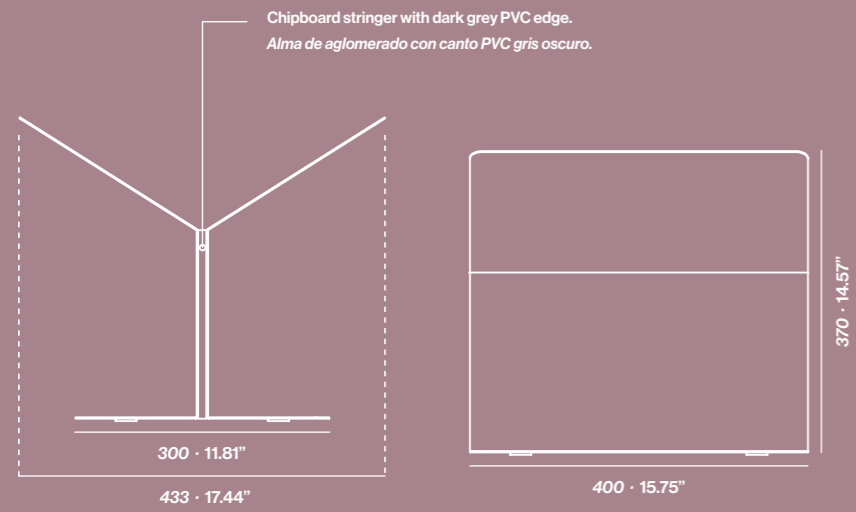

mm · inches

Mott



**Elegance and simplicity  
go hand in hand.**

*Elegancia y sencillez van de la mano.*

EN Singular magazine rack. Its structure allows to be use as a side table, by adapting a transparent glass top. Made of light gray screen fabric, and chromed or painted steel structure.

ES Singular revistero. Su estructura permite el uso como mesa auxiliar al incorporar un sobre de cristal transparente. Fabricado con tejido de screen gris claro y estructura de acero cromada o pintada.



Zin by  
Fernando Gil

Zin

¿Es un revistero? ¿Es una mesa auxiliar? ¡Es ambos!

**Is it a magazine rack?  
Is it a side table? It is both!**

ZIN

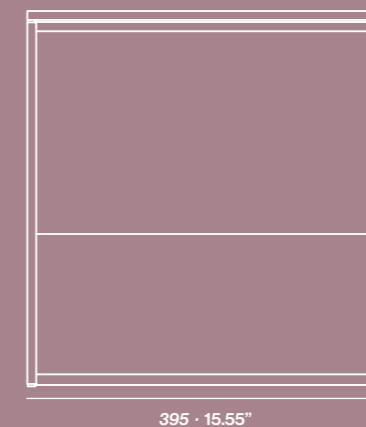
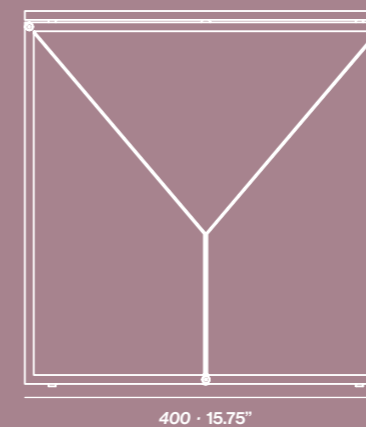

403 · 15.87" Without glass top.  
Sin tapa de cristal.  
415 · 16.34" With glass top.  
Con tapa de cristal.

mm · inches

Zin

EN Discreet support for fire extinguishers made of painted steel sheet. The wheels on the freestanding models allow for convenient mobility.

ES Soporte discreto para extintores fabricado en plancha de acero pintada. Las ruedas de los modelos autoportantes permiten un cómodo desplazamiento.

Faya by  
STC Studio

# Faya





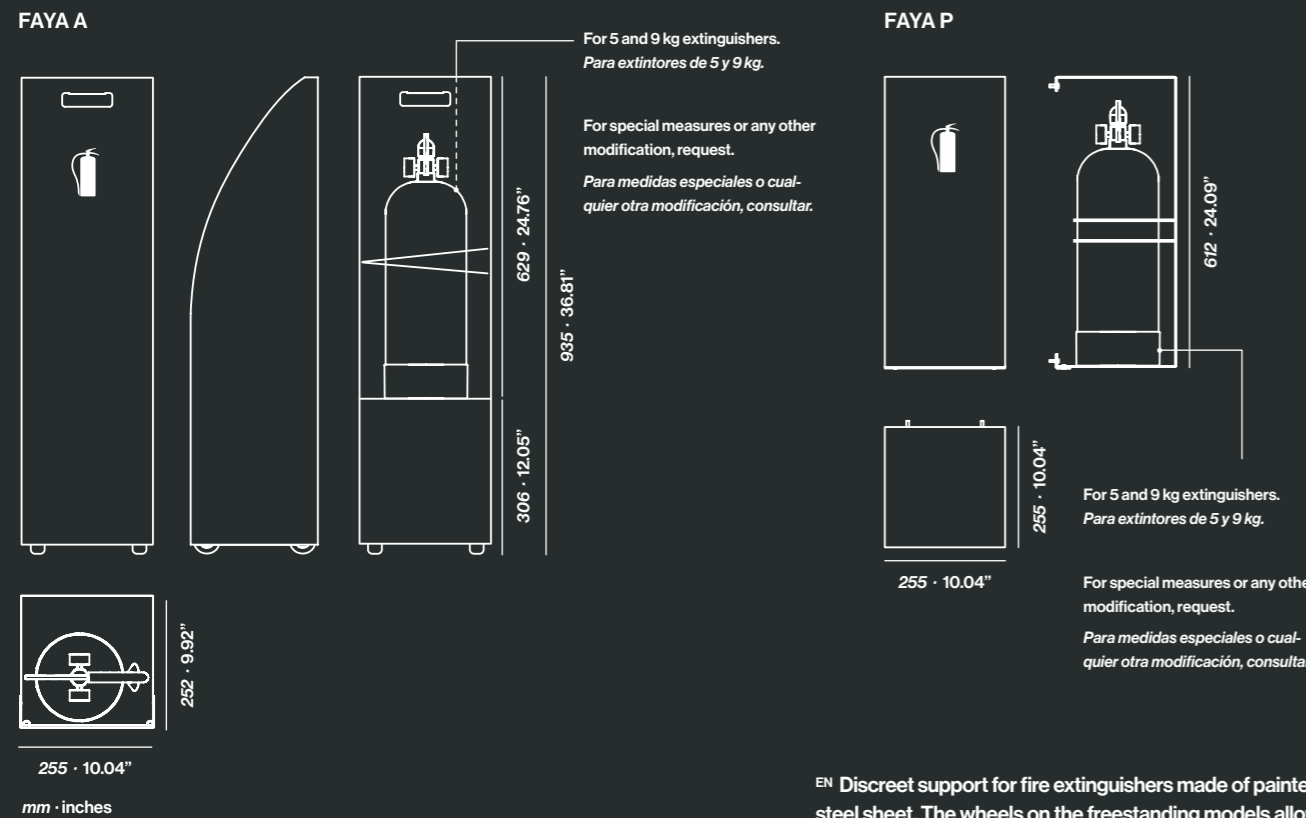
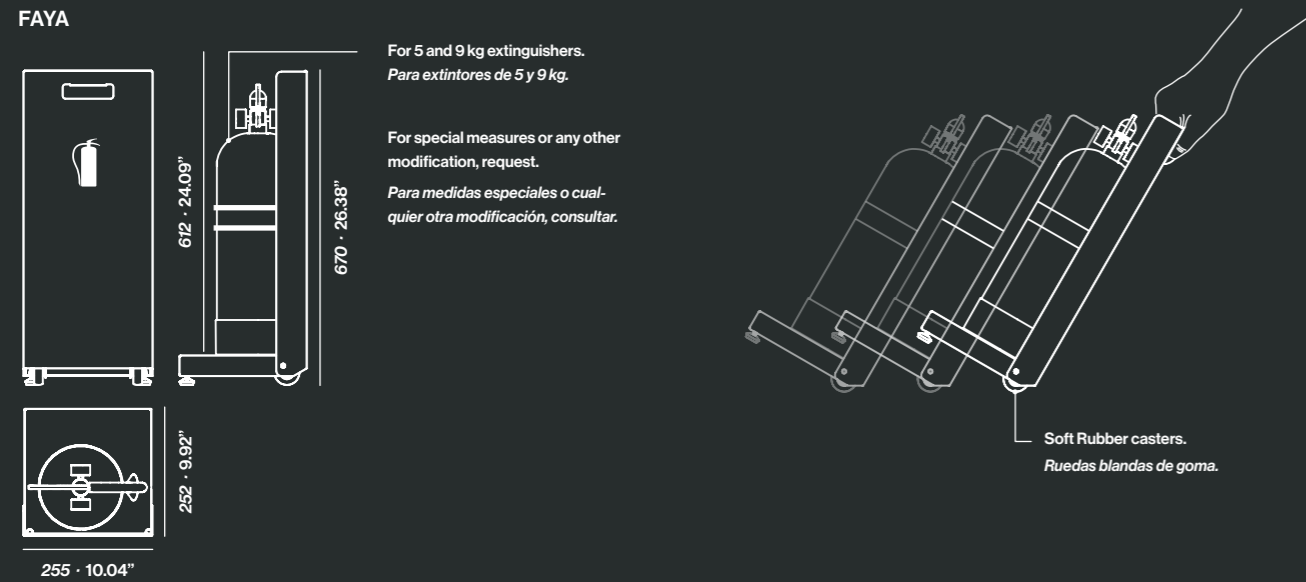

Faya

EN Discreet support for fire extinguishers made of painted steel sheet. The wheels on the freestanding models allow for convenient mobility.

ES Soporte discreto para extintores fabricado en plancha de acero pintada. Las ruedas de los modelos autoportantes permiten un cómodo desplazamiento.



Security with elegance.

Seguridad con elegancia.



Fum by  
STC Studio

## Fum

Tres modelos. Fácil mantenimiento.

# Three models. Easy maintenance.

### FUMPI

Self standing ashtray column.  
Capacity: 0.7 liters.

Columna cenicero de pie.  
Capacidad: 0.7 litros.

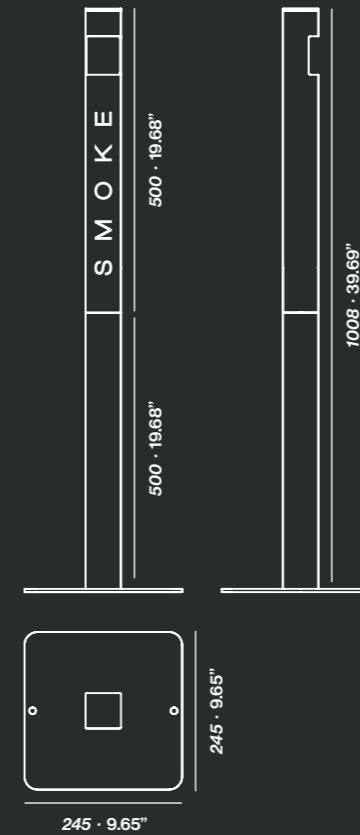

### FUMPI2

Self standing ashtray column.  
Capacity: 1.4 liters.

Columna cenicero de pie.  
Capacidad: 1.4 litros.

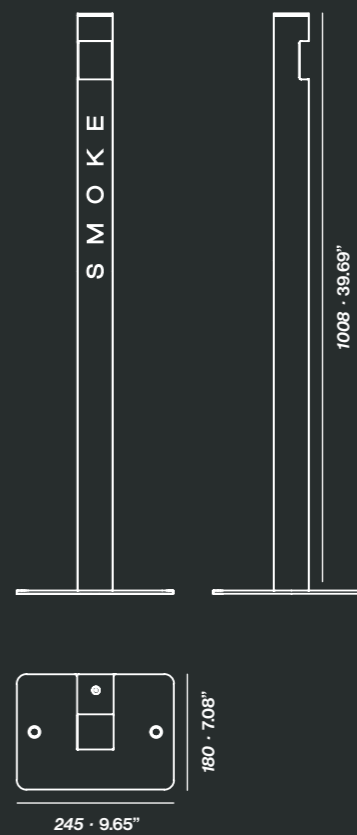

### FUMPA

Wall hanged ashtray column.  
Capacity: 0.7 liters.

Columna cenicero a pared.  
Capacidad: 0.7 litros.

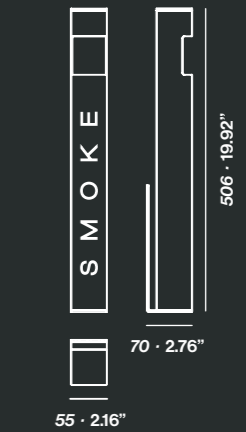

mm · inches

## Fum

EN Ashtray column made of painted aluminum. A sealed tank that reduces smoke and smells is included. Two formats: on the wall or standing, being able to screw it to the ground.

A standing version with double capacity is offered.

ES Columna cenicero de aluminio pintado que incluye un depósito sellado para reducir el humo y los malos olores. Dos formatos: a pared o de pie, pudiéndose atornillar a suelo.

Se ofrece una versión de pie con el doble de capacidad.



Trec by  
STC Studio

Trec

*Establece límites a todo menos a tus objetivos.*

**Set limits to everything  
but your goals.**

TEPIE

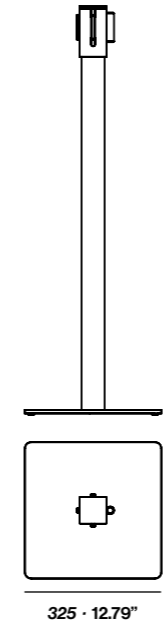

TEPA

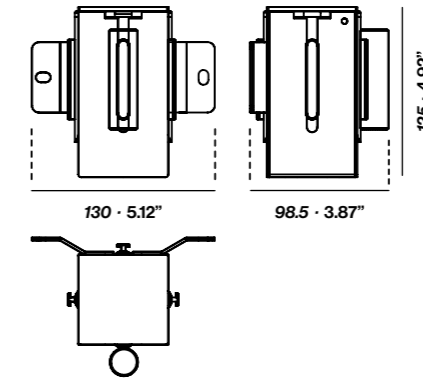

TEEXP

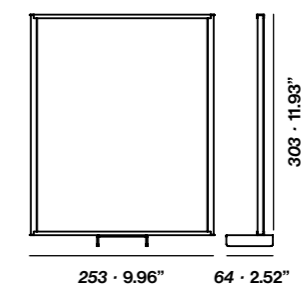

TECHE

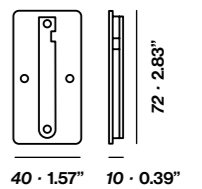

mm · inches

**Trec**

**EN** Collection of posts for delimiting public spaces. Squared aluminum column and painted steel base. 3m (9.84 feet) tape available in blue, red or black.

**ES** Colección de postes para delimitar espacios públicos. Columna cuadrada de aluminio y base de acero pintado. Carrete de 3m disponible en azul, rojo o negro.



Store by  
STC Studio

## Store

Optimiza tu espacio de trabajo.

# Optimize your workspace.

## STORE

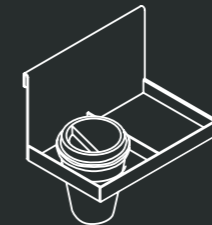
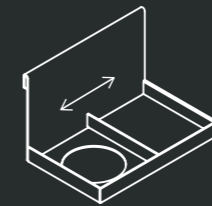
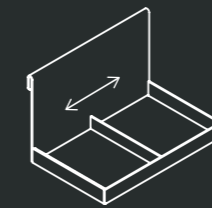
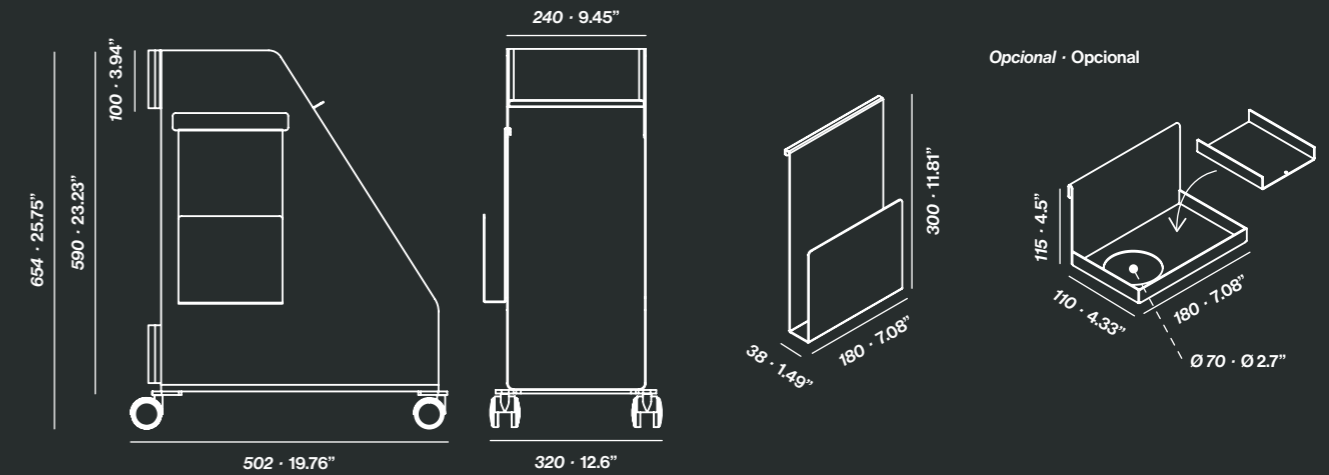

mm · inches

## Store

**EN** Personal auxiliary furniture, designed to optimize workspaces thanks to its functionality and mobility, thought-out to hold handbags, jackets, wallets, bags, phones, tablets, laptops, and any kind of personal items. Includes a magazine rack and a handle that facilitates its movement. An adapted shelf to support drinks and to hold up little objects is optional. Both complements can be hanged on one side or another to improve the user ergonomics. Made of steel.

**ES** Mueble auxiliar personal diseñado para optimizar los espacios de trabajo por su funcionalidad y movilidad, pensado para contener bolso, chaqueta, cartera, mochila, móvil, tablet, portátil y cualquier tipo de objeto personal. Incluye un revistero y un tirador que facilita su desplazamiento. Se puede disponer de un estante adaptado para sostener bebidas y apoyar objetos pequeños. Ambos complementos pueden colocarse a un lado u otro del mueble para mejorar la ergonomía del usuario. Fabricado en plancha de acero.





Office set by  
STC Studio

## Office set

Más que accesorios, herramientas para tu comodidad.

# More than accessories, tools for your comfort.

### SWIRE

Rectangular desktop grommet metallic and lacquered.  
Pasacables rectangular de sobremesa metálico y lacado.

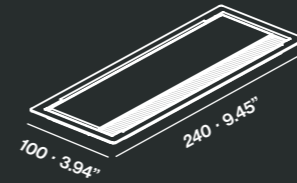

### OMEGASTC

Metal grommet strip.  
Regleta pasacables metálica.

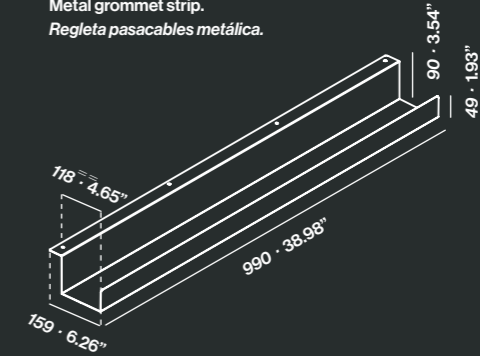

### CPURD

CPU Support with casters.  
Soporte de CPU con ruedas.

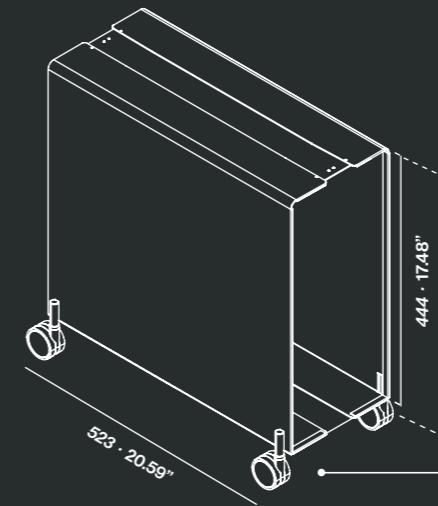

### CPUSTC

CPU hanging support.  
Soporte colgante de CPU.

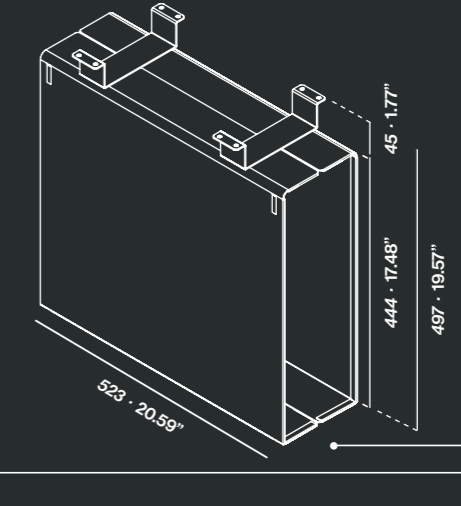

150 - 200 - 250 mm  
5.90" - 7.87" - 9.84"

mm · inches

# Swire / Omega / CPU

EN Set of accessories that allows the organization of office items in working spaces.

ES Serie de accesorios que permiten la organización de elementos de oficina en espacios de trabajo.



WID

WIS

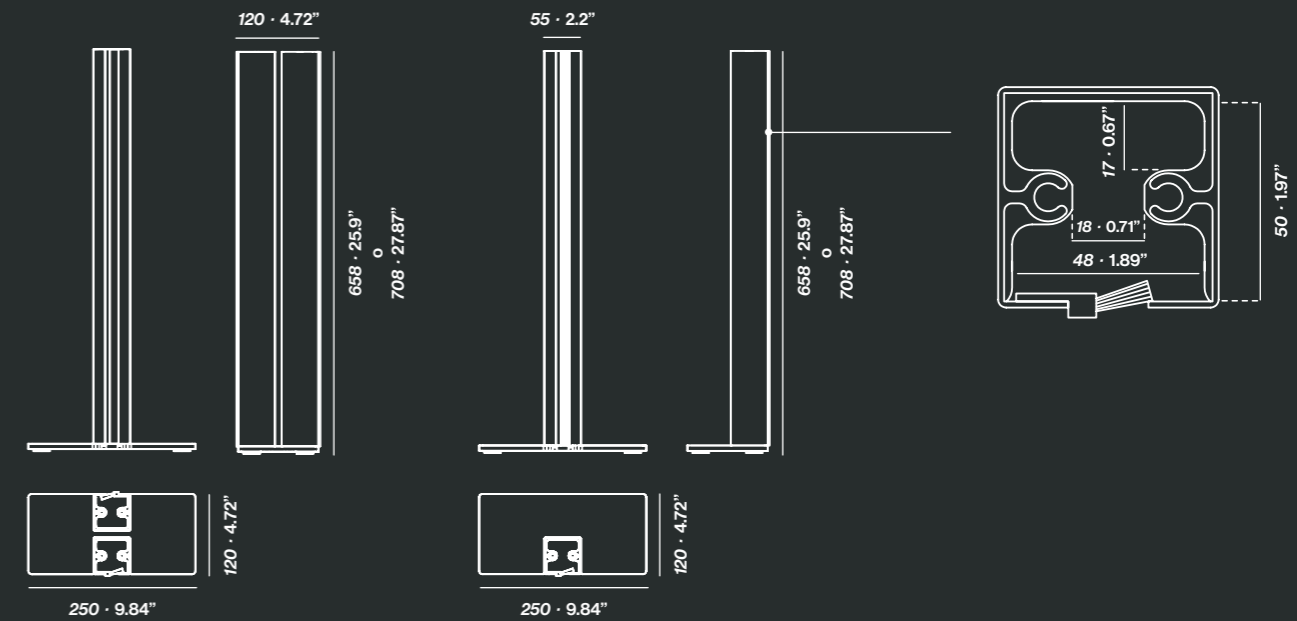
Office set by  
STC Studio

## Office set

Organiza tus instalaciones.

# Organize your facilities.

mm · inches

## Wire

**EN** Freestanding aluminum column to hide cable, with two versions: single or double. It includes a black brush on its side that allows inserting and removing cables easily. Its base is designed for facilities with technical floors.

**ES** Columna autoportante de aluminio para ocultar cables. Presenta dos versiones: sencilla o doble. Incluye un cepillo negro en el lateral que permite introducir y extraer cables fácilmente. Su base está diseñada para instalaciones con suelos técnicos.

Office set by  
STC Studio

## Office set

Una solución ergonómica.

# An ergonomic solution.

## SUPP

EN Computer screen support made of one steel sheet that allows to save the keyboard underneath.

ES Soporte para pantallas de ordenador fabricado con una única plancha de acero que permite guardar el teclado debajo.

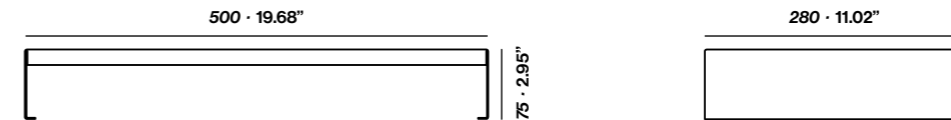

## SUPPORT

EN This laptop stand allows you to adopt an ergonomically correct posture while working.

ES Este soporte para ordenador portátil permite adoptar una postura ergonómicamente correcta durante el trabajo.

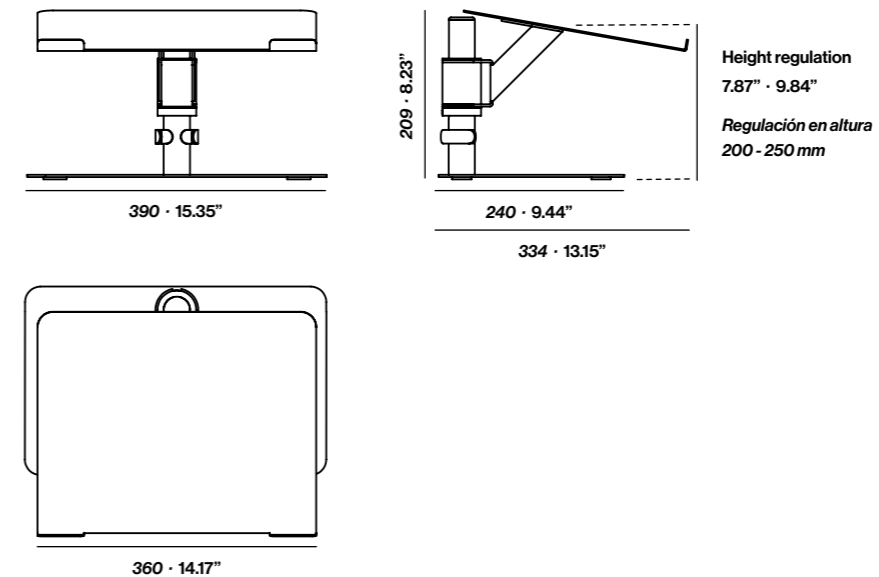

mm · inches

# Supp / Support



<sup>EN</sup> Freestanding vertical panel used as a notice panel by adapting magnetic elements. It also supports the room divider function. Made of steel and coated with oven thermoset powder paint.

<sup>ES</sup> Panel vertical autoportante usado como panel informativo mediante la adaptación de elementos magnéticos. Admite la función de separador de ambientes. Está fabricado en acero y recubierto con pintura en polvo termo-endurecida al horno.

Lit by  
Pablo Gironés

Lit



LIT

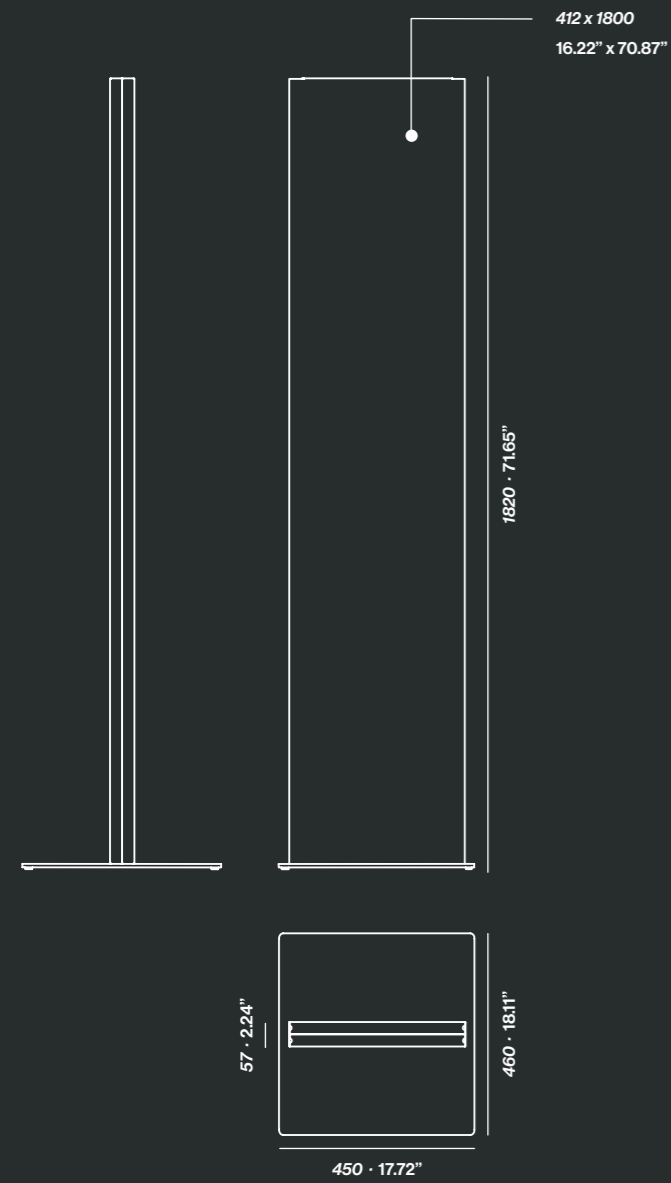

mm · inches

Lit



## Two functions, one product!

*¡Dos funciones, un producto!*



Flap by  
STC Studio

# Flap

Muestra tus ideas.

# Display your ideas.

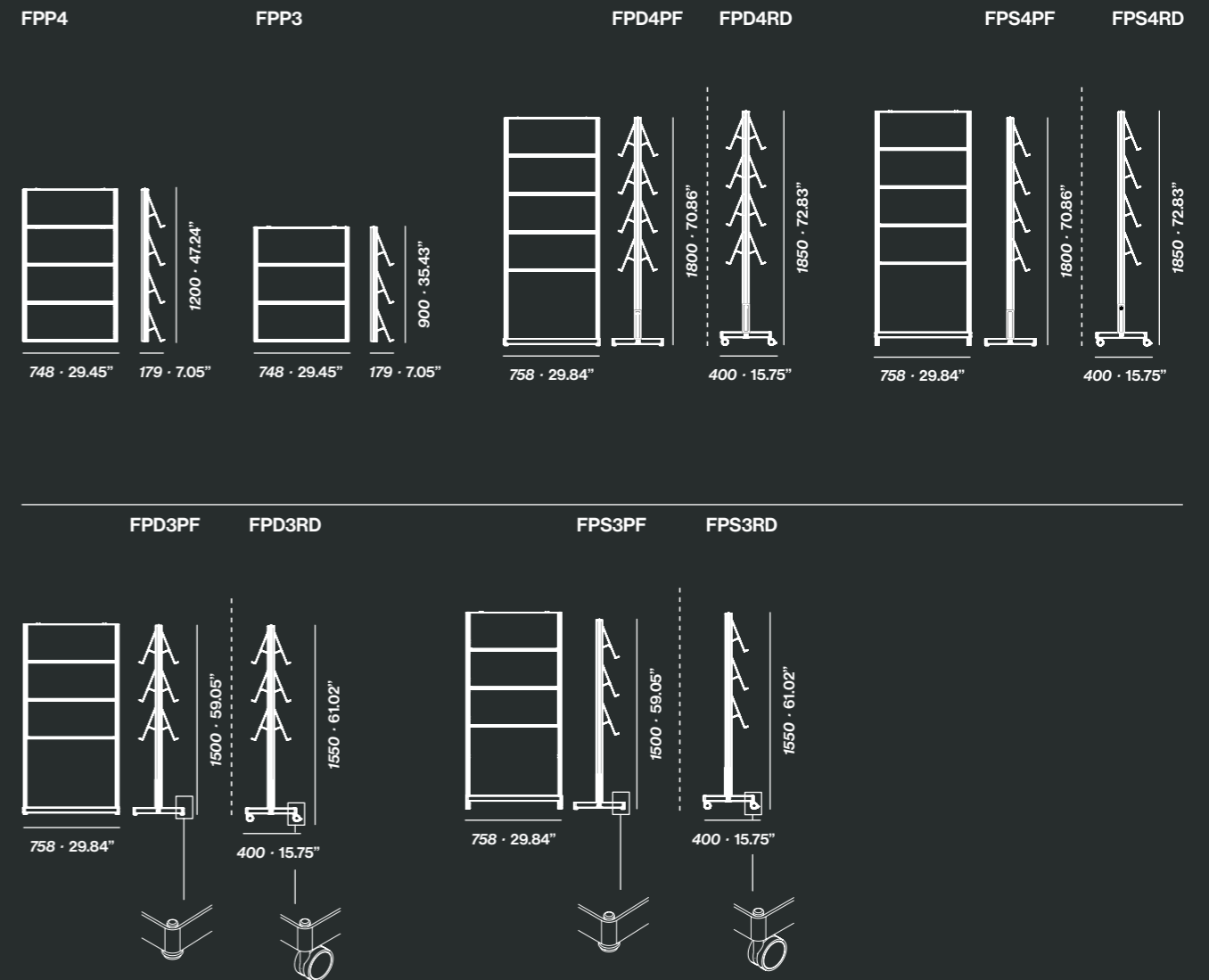

mm · inches

# Flap

**EN** Vertical display for magazines, newspapers, catalogues, brochures... It presents the options wall-mounted or freestanding, with adjustable feet or casters. Shelves may be on one side or both. Aluminum structure with anodized silver finish. Steel shelves and base, both coated with oven thermoset powder paint. Capacity per shelf: A4 (x3).

**ES** Expositor vertical para revistas, periódicos, catálogos, folletos publicitarios... Presenta las opciones a pared y autoportante con pies niveladores o ruedas y estantes a una cara o a ambas. Estructura de aluminio anodizado plata mate. Estantes y base de acero con revestimiento de pintura en polvo termoendurecida al horno. Capacidad por estante: A4 (x3).



Modulor by Pablo Gironés

## Modulor

Mantén a todos actualizados.

# Keep everyone up to date.

MODULOR\_S



MODULOR\_M



A special white finish version allows writing with dry erase markers.  
 Un acabado especial blanco permite escritura con rotuladores de borrado en seco.

MODULOR\_L

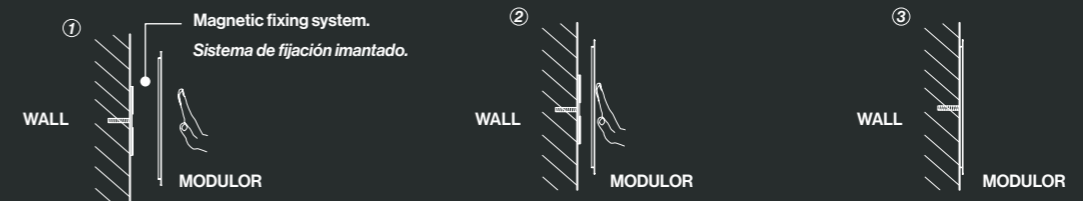
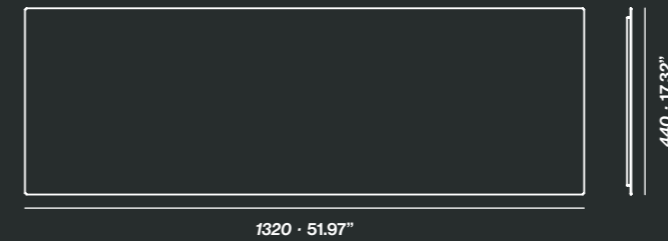

mm · inches

## Modulor

EN Metallic notice panels of different sizes and colors that allow adapting magnetic elements and create singular wall compositions in many spaces: informative points, offices, receptions, children's rooms, etc. A special white finish version that allows writing with dry erase markers, is offered.

ES Paneles informativos metálicos de diversas dimensiones y colores que permiten adaptar elementos magnéticos y crear originales composiciones de pared en múltiples espacios: puntos informativos, oficinas, recepciones, habitaciones infantiles, etc. Disponible un acabado especial blanco que permite escritura con rotuladores de borrado en seco.



Iflag by  
STC Studio

**Iflag**

*Rompimos la ley de la gravedad.*

**We broke the law of gravity.**

**IFS Simple · Simple**

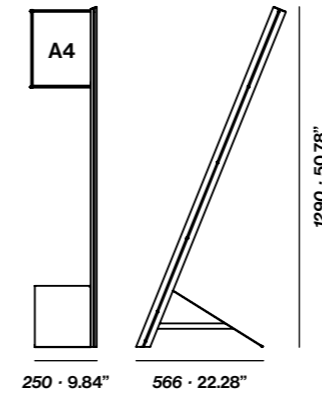

**IFD Double · Doble**

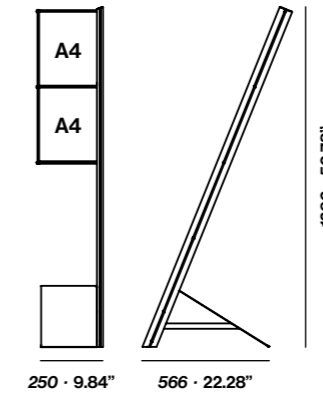

**IFT Triple · Triple**

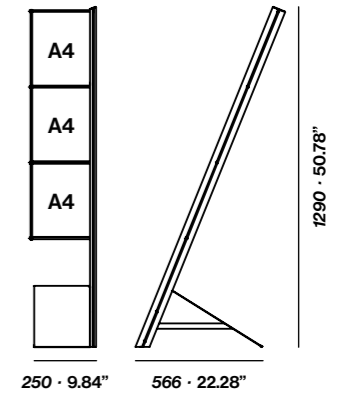

**IFS Simple with shelf · Simple con repisa**

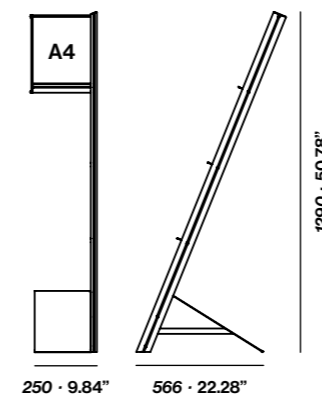

**IFD Double with shelf · Doble con repisa**

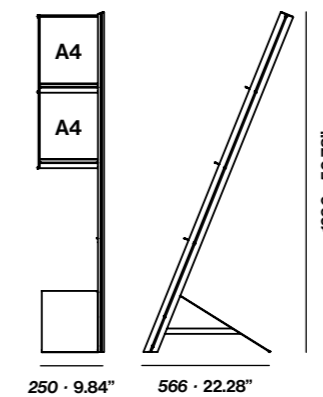

**IFT Triple with shelf · Triple con repisa**

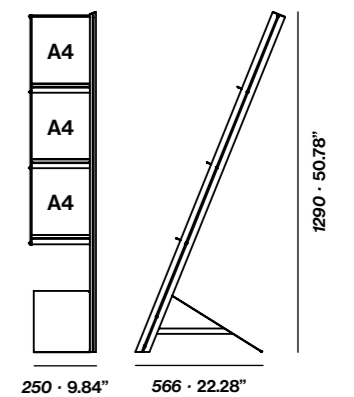

mm · inches

**Iflag**

**EN** Transparent methacrylate display (A4 format).  
Versions: single, double or triple, with or without shelves.  
Aluminum column with anodized silver finish and steel base coated with oven thermoset powder paint.

**ES** Expositor de metacrilato transparente (formato A4).  
Versiones: simple, doble o triple, con o sin repisas.  
Columna de aluminio anodizado plata mate y base de acero recubierta con pintura en polvo termoendurecida al horno.

## Atria

**What you see is what it is:  
light, elegant, timeless.**

*Lo que ves es lo que es: ligero, elegante, atemporal.*



Atria by  
STC Studio



### ATRIA

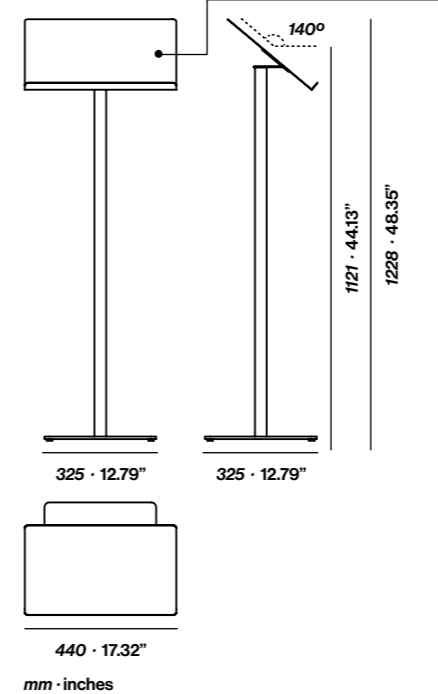

A 440 x 317 · 17.32" x 12.48.

Up to DIN A3.

Hasta tamaño DIN A3.

## Atria

**EN** Light structure lectern. It has an aluminum column and a painted steel base and tray.

**ES** Atril de ligera estructura. Combina materiales como el aluminio de la columna y el acero pintado de su base y bandeja.

Conoce nuestra familia.

# Meet our family.

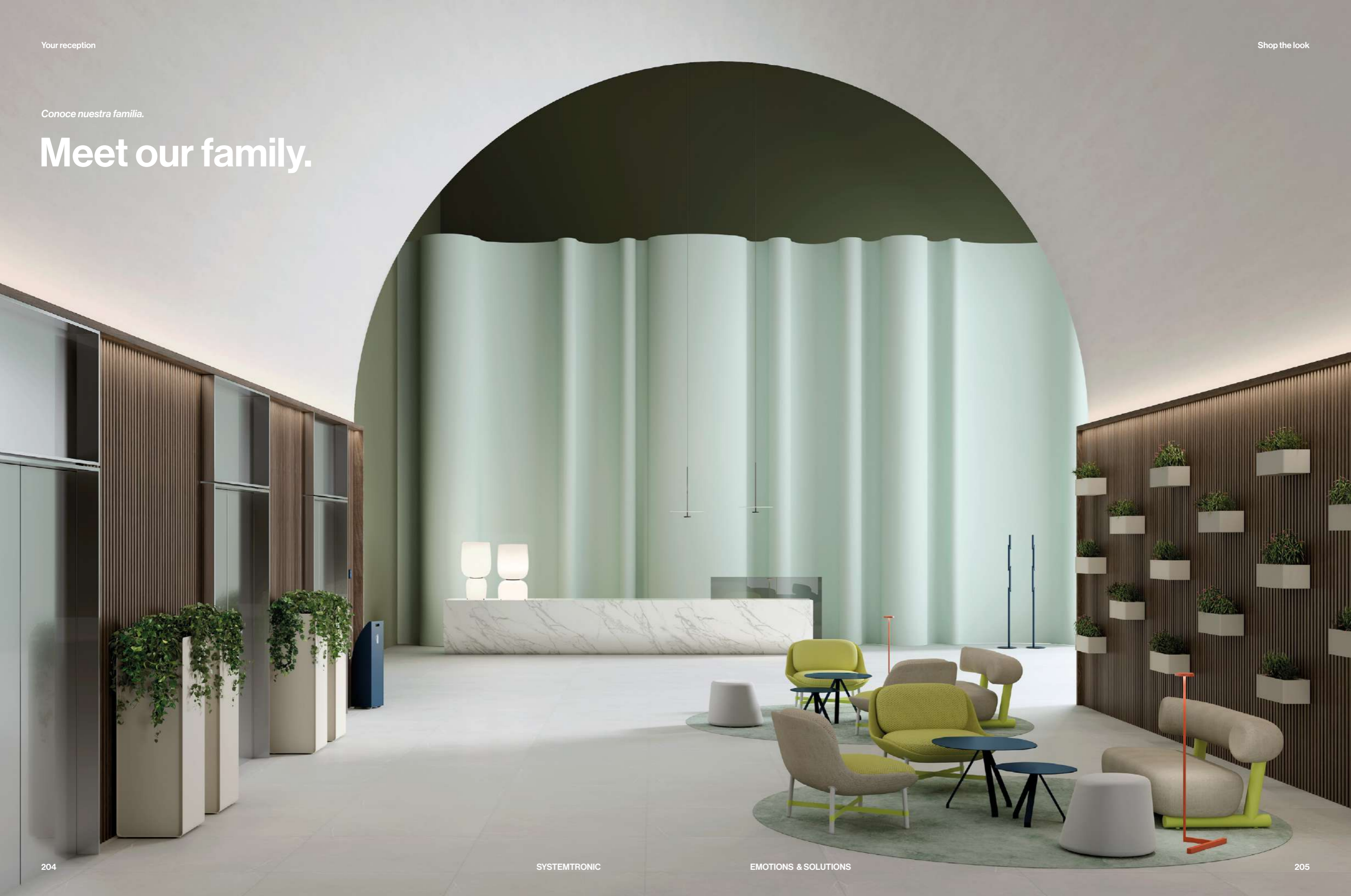

systemtronic



01



02



03



04



05



06

**EN** The design of current hotel spaces is expected to combine aesthetics, functionality, and sustainability to create environments that are both pleasant and practical for guests and staff alike.

Systemtronic offers a wide range of products ideal for both cozy common areas and well-equipped rooms: recycling bins in various sizes, side tables, shelves, TV stands, benches, wardrobes, planters, display units... These products are designed to meet the highest standards of quality and durability, ensuring their resistance and functionality in demanding environments.

**ES** De los espacios hoteleros actuales se espera que su diseño combine estética, funcionalidad y sostenibilidad para la creación de ambientes que resulten agradables y prácticos tanto para los huéspedes como para el personal.

Systemtronic cuenta con una amplia gama de productos ideales tanto para áreas comunes acogedoras como para habitaciones bien equipadas: papeleras de reciclaje de varias dimensiones, mesas auxiliares, estanterías, soportes de televisión, bancos, armarios, jardineras, expositores... Se trata de productos diseñados para cumplir con los más altos estándares de calidad y durabilidad, asegurando su resistencia y funcionalidad en entornos exigentes.

**Shop the look** *Compra el conjunto*

01 CREPE - Plant pots 02 GREEN LIGHT - Wall plant pots 03 CELES - Side tables 04 FAYA - Fire extinguisher support 05 NANAME - Coat racks  
06 CONEE - Poufs.

Conoce nuestra familia.

**Meet our family.**



<sup>EN</sup> Naname is the coat stand that represents the moment when the bamboo is being cut with a sword, slipping down. The textured gold finish is offered exclusively for this reference.

<sup>ES</sup> *Naname es el perchero que representa el momento en que el bambú se corta con una espada y cae. Fabricado en acero. Se ofrece exclusivamente para esta referencia el acabado oro texturado.*

Naname by  
Kodai Iwamoto

# Naname



NANAME

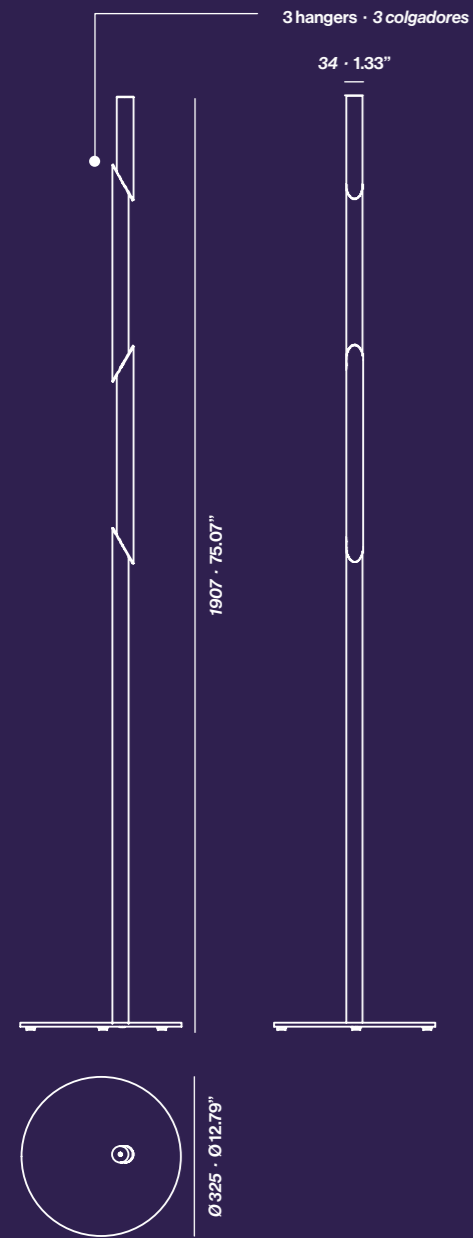

mm · inches

# Naname



**As sculptural as functional.  
Nature-inspired.**

*Tan escultórico como funcional.  
Inspirado en la naturaleza.*

EN The coat stand Second Tree is the abstraction of the nature forms, conserving the oak-tree's soul and warmth. It stands out for its fine finish, following Systemtronic's quality philosophy, and the contrast that provides combining a noble material with steel.

ES *El perchero Second Tree es la abstracción de formas de la naturaleza conservando el alma y la calidez del roble. Destaca por la calidad de su acabado y el contraste que aporta al combinar el material noble con el acero.*

Second Tree by  
Pablo Gironés

# Second Tree



SECOND TREE

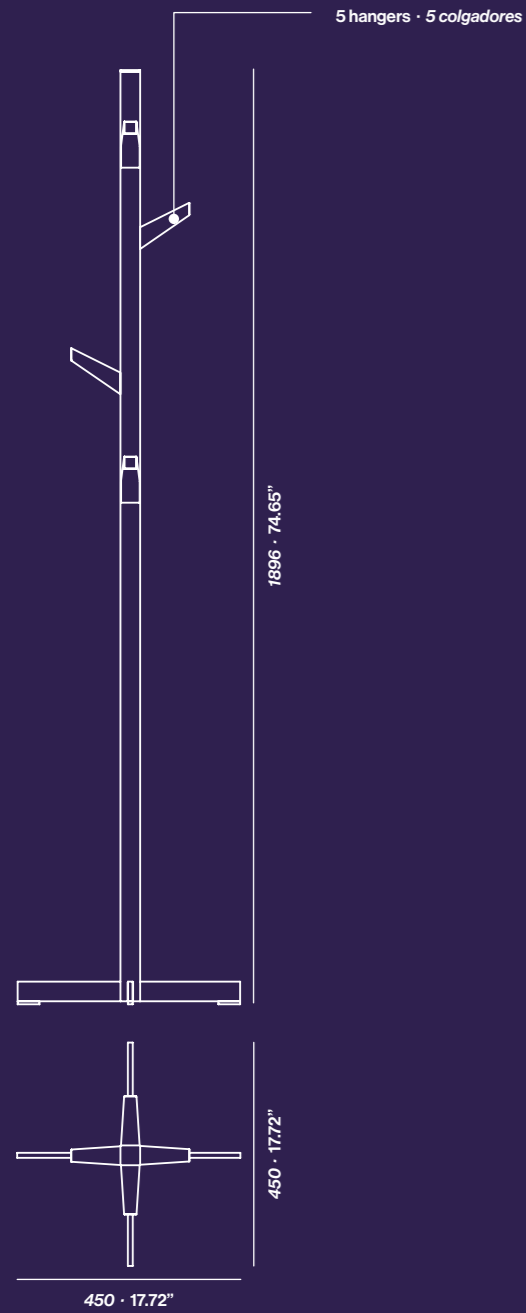

mm · inches

# Second Tree



**Order and style in one place.**

*Orden y estilo en un solo lugar.*

EN Wall-mounted coat rack composed of natural oak wood hangers on a metal plate.

ES *Perchero a pared compuesto por colgadores de madera natural de roble sobre una plancha metálica.*

Second Tree Wall by  
Pablo Gironés

# Second Tree Wall



SECOND TREE WALL

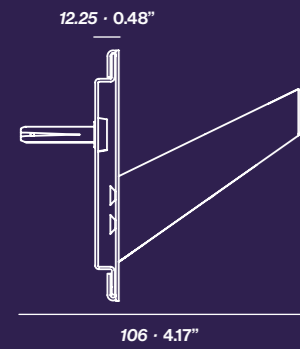
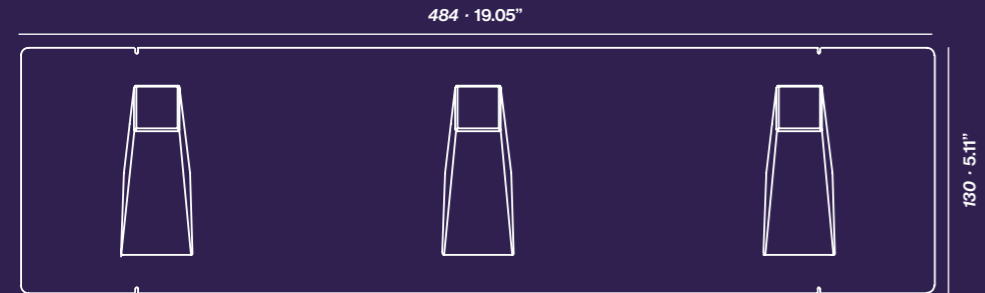

mm · inches

# Second Tree Wall



## Your style always at hand.

*Tu estilo siempre a mano.*



**EN** Exclusive coat stand formed by beech wood bars and a steel ring painted in several colors.

**ES** *Perchero exclusivo compuesto por barras de madera de haya y un aro de acero pintado en varios colores.*

Ker by  
Lluïsa Morató

**Ker**

KER

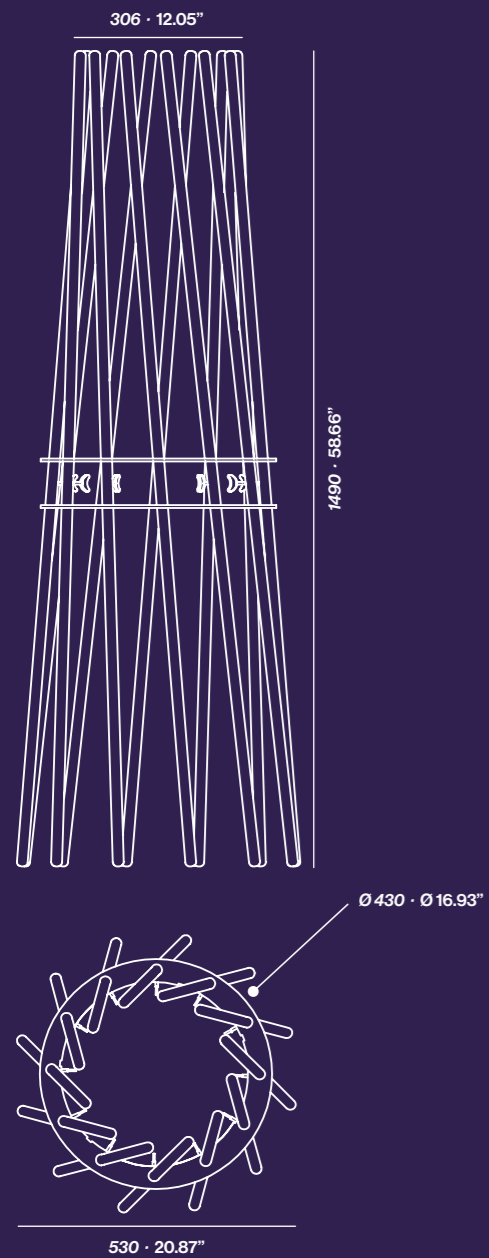

mm · inches

**Ker**



**There is no chaos  
when there is Ker.**

*No hay caos cuando hay Ker.*





Elica by Fernando Gil

ELICA

ELICA\_UMBRELLA

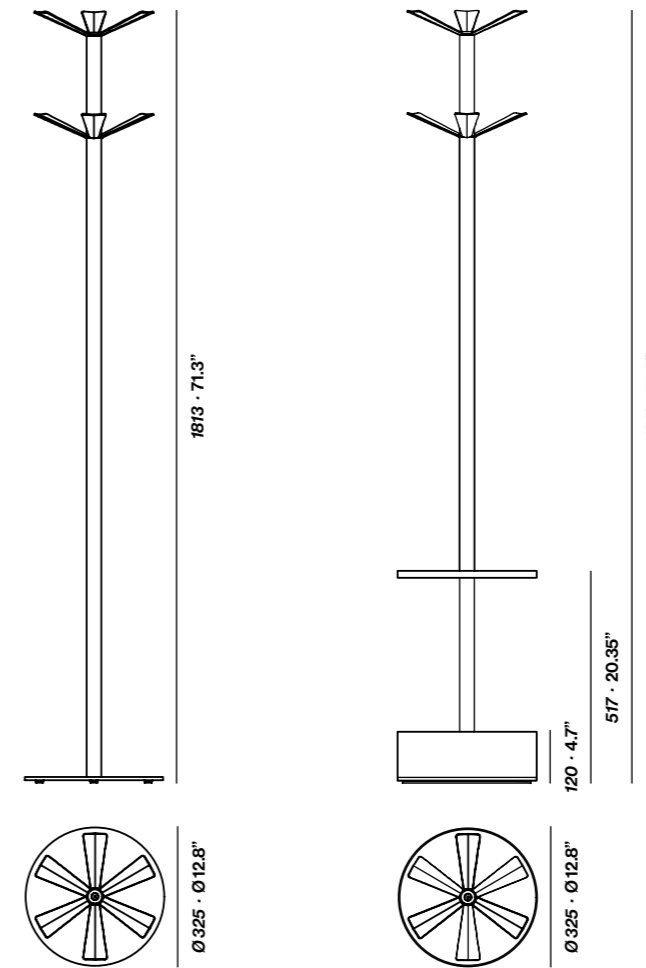

mm · inches

# Elica

¡La mejor manera de decir bienvenido!

# The best way to say welcome!

# Elica

EN Coat racks family. One of its versions shares the function of umbrella stand. The layout and design of its propellers optimize the space.

ES Familia de percheros. Una de sus versiones comparte la función de paraguero. La disposición y el diseño de sus hélices optimizan el espacio.

**EN** Elica Mini is light and portable, allowing you to have your belongings close and in sight.

**ES** *Elica Mini es ligero y portátil, lo que permite mantener tus pertenencias cerca y a la vista.*

Elica Mini by  
Fernando Gil

# Elica Mini



ELICA\_MINI



714 · 28.11"



Ø 230 · Ø 9"

mm · inches

# Elica Mini



**Now comfort is portable,  
take it with you.**

*Ahora la comodidad es portátil, llévala contigo.*

**EN** Coat stand with metallic hangers that evoke the branches of a tree. Available in several finishes.

**ES** *Perchero con colgadores metálicos que evocan las ramas de los árboles. Disponible en varios acabados.*

Branch by  
STC Studio

# Branch



BRANCH

5 hangers · 5 colgadores

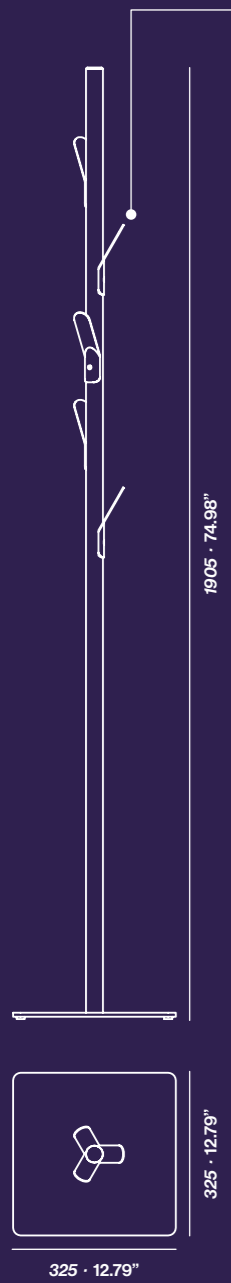

mm · inches

# Branch



## The strength of metal, the touch of design.

*La fuerza del metal, el toque del diseño.*

**EN** Lightness and stability defines this piece. A coat rack formed by two columns of anodized aluminum with a matte silver finish. There are two versions: with casters or with adjustable feet. Its steel base and bottom rail may have a white, black or anthracite gray finish. The upper crossbar has a chrome finish. One of its versions allows adapting a metallic shelve adjustable in height and a cover on the base.

**ES** *Ligereza y estabilidad definen a este producto, compuesto por dos columnas de aluminio anodizado con un acabado plata mate. Está disponible con ruedas o pies regulables. Su base y travesaño inferior de acero pueden tener un acabado blanco, negro o gris antracita. El travesaño superior presenta un acabado cromado. El Inlin de anchura 758mm permite adaptar un estante metálico regulable en altura y una tapa en la base.*

Inlin by  
STC Studio

# Inlin



**INL15PF** adjustable feet · *pies regulables*      **INL15RD** wheels · *ruedas*  
**INL7PF / INL15PF** adjustable feet · *pies regulables*      **INL7RD / INL15RD** wheels · *ruedas*

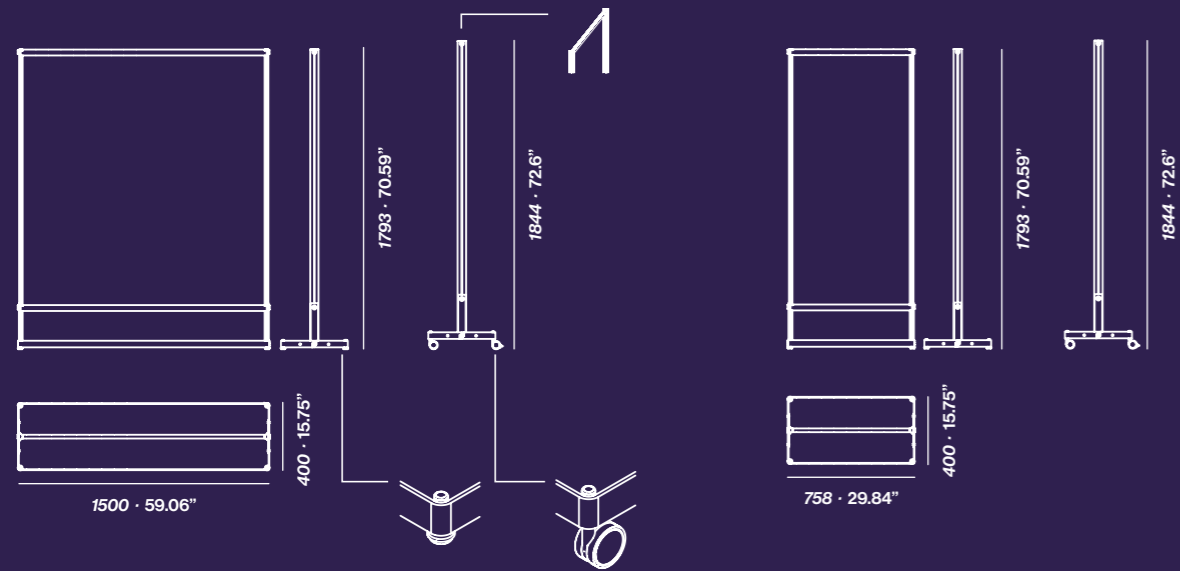

**INLD15PF** adjustable feet · *pies regulables*      **INLD15RD** wheels · *ruedas*  
**INLIN 758** accessories · *accesorios*

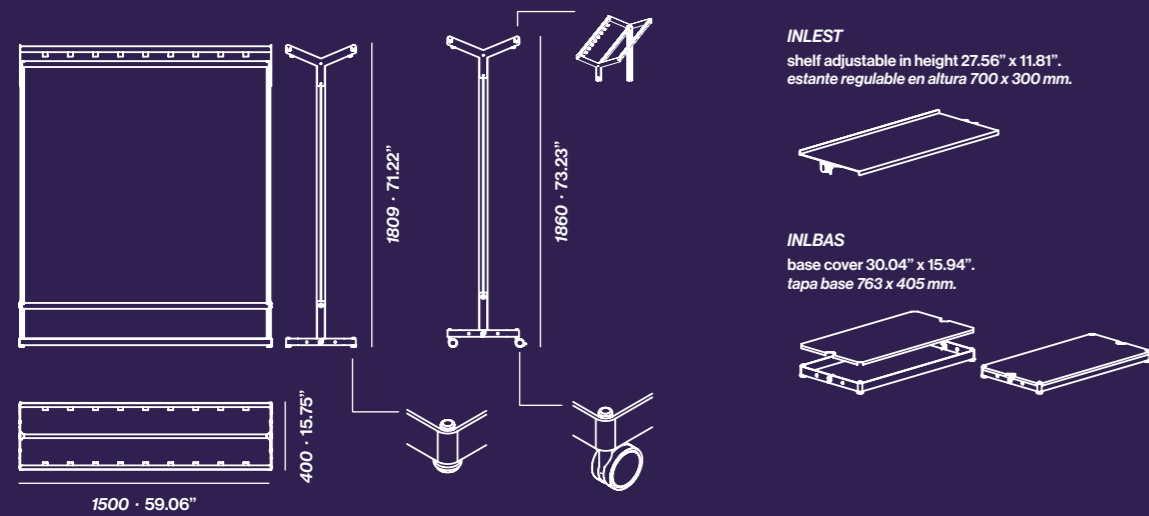

mm · inches

**Inlin**



**Versatile design, extreme capacity.**

*Diseño versátil, capacidad extrema.*

# Cantha

**EN** Wall sconce with indirect light to create soft, diffused illumination. Available in two sizes, it can be combined with the hangers from the same family.

**ES** *Aplique con luz indirecta para crear una iluminación difusa y suave. Disponible en dos tamaños, se puede combinar con los colgadores de la misma familia.*

Cantha by  
Paula Chacartegui



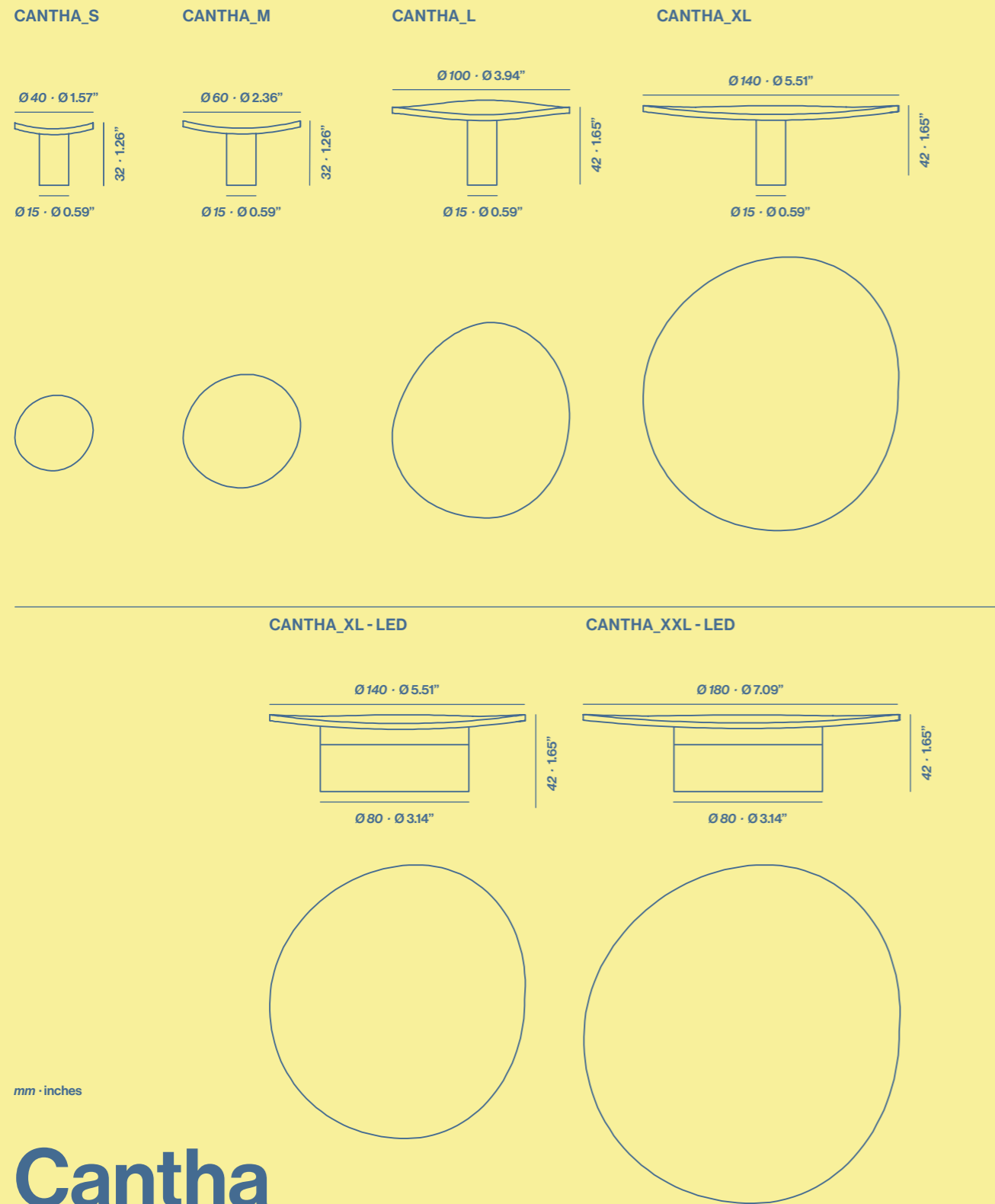

mm · inches

# Cantha

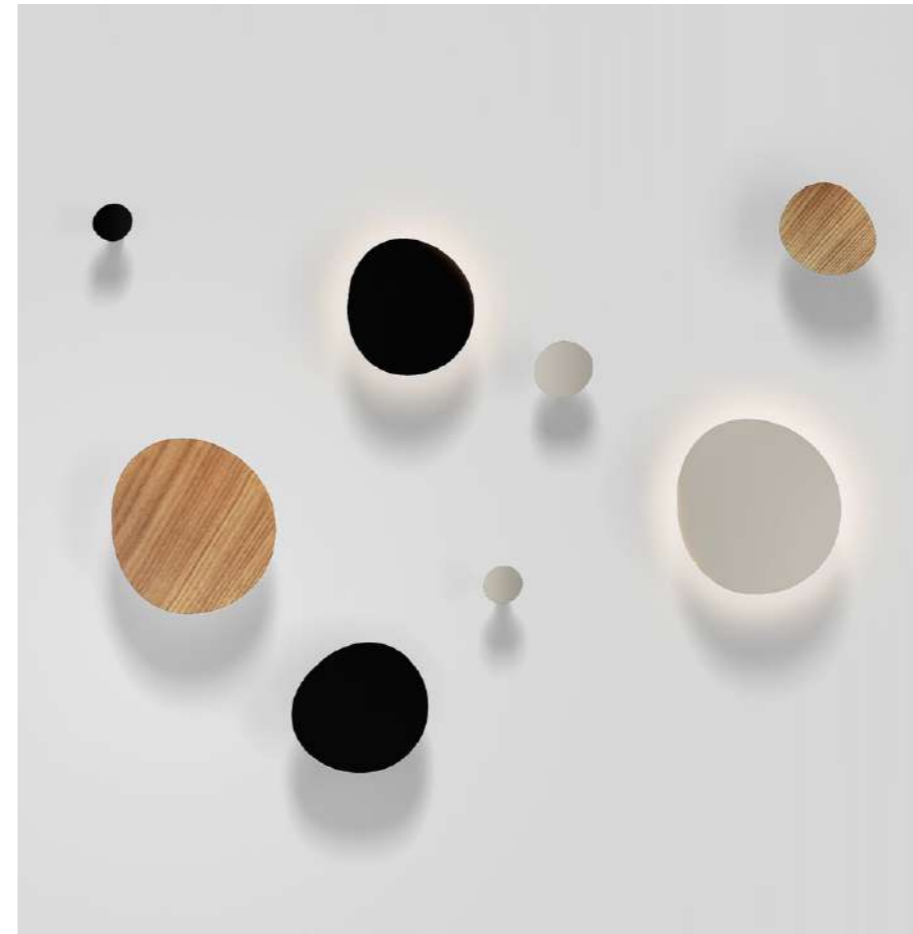

## Smooth and easy-to-follow lines.

*Líneas suaves y fáciles de seguir.*

EN Hangers of different sizes made of aluminum. There are two models that function as light fixtures.

ES Colgadores de distintos tamaños fabricados en aluminio. Existen dos modelos que funcionan como apliques de luz.



## Inper

# The perfect combination!

*¡La combinación perfecta!*

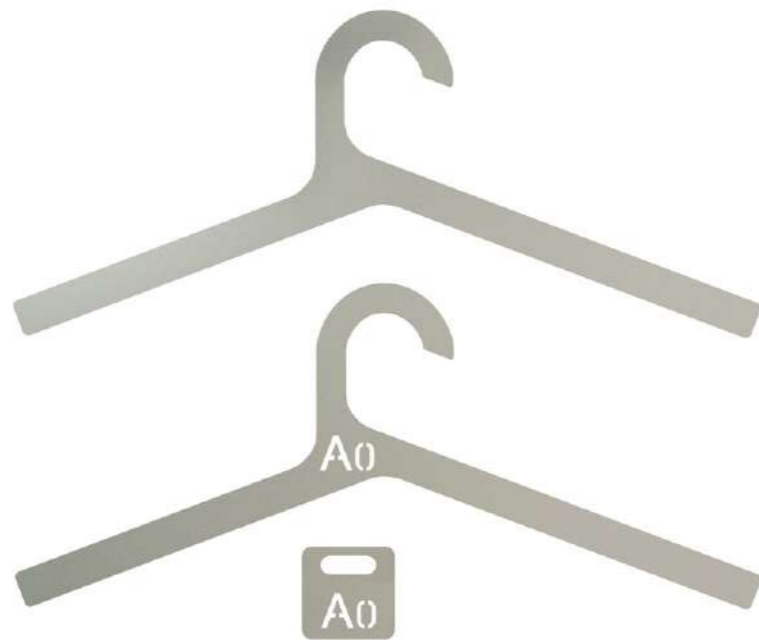

Inper by  
STC Studio

**EN** Stylish and lightweight hangers made in sandblasted aluminum and available with or without alphanumeric identification. These hangers complement other Systemtronic products such as: Inlin, Buraco, Pointo, Climb... Minimum order of 10 units is required for alphanumeric identification (0-9). Code letters according to stock availability.

**ES** Elegantes y ligeras perchas de aluminio arenado disponibles con o sin identificación alfanumérica. Estas perchas complementan otros productos de Systemtronic como Inlin, Buraco, Pointo, Climb... Para pedidos de perchas con identificación alfanumérica, la cantidad mínima es de 10 unidades (0-9). La letra varía según disponibilidad en stock.

INLPC

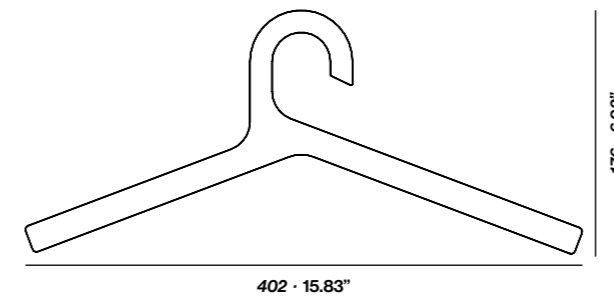

INLPCIN

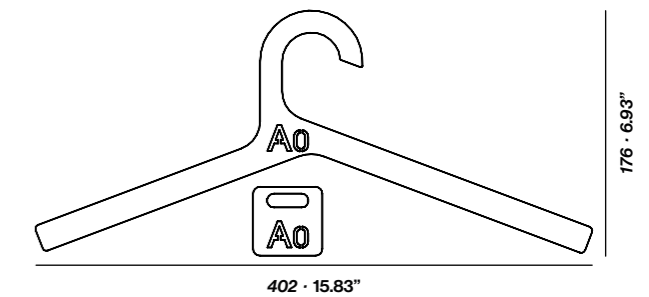

mm · inches

## Inper

EN Wall rack made of aluminum and available in six different lengths. The hanger fixing system on the profile simplifies its assembly.

ES *Perchero de pared fabricado en aluminio y disponible en seis longitudes diferentes. El sistema de fijación de los colgadores al perfil simplifica su montaje.*

Climb by  
STC Studio

## Climb

*Función y forma en su estado puro.*

**Together, function and  
form in their purest state.**





**CL11**  
1 hanger · 1 colgador



44 · 1.73"

Maximum recommended weight 4 kg.  
Peso máximo recomendado 4 kg.

**CL12**  
2 hangers · 2 colgadores

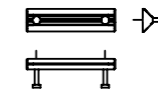

194 · 7.63"

Maximum recommended weight 10 kg.  
Peso máximo recomendado 10 kg.

**CL13**  
3 hangers · 3 colgadores

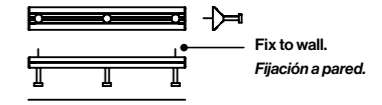

344 · 13.54"

Maximum recommended weight 10 kg.  
Peso máximo recomendado 10 kg.

**CL14**  
4 hangers · 4 colgadores

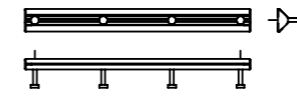

494 · 19.44"

Maximum recommended weight 10 kg.  
Peso máximo recomendado 10 kg.

**CL17**  
7 hangers · 7 colgadores

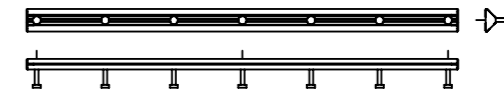

944 · 37.16"

Maximum recommended weight 15 kg.  
Peso máximo recomendado 15 Kg.

**CL15**  
15 hangers · 15 colgadores

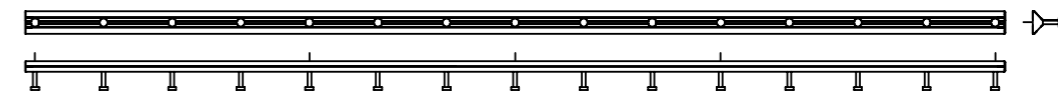

150 · 5.91"

Maximum recommended weight 20 kg.  
Peso máximo recomendado 20 kg.

2144 · 84.41"

Zoom

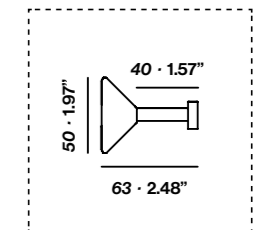

mm · inches

# Climb

**EN** Attractive hangers with a variety of colors and shapes, allowing multiple compositions on walls. Manufactured in painted steel plate, or combined with a matte oak finish front. They have a simple fixation system, either anchored to the wall or magnetic.

**ES** *Atractivos colgadores que por la variedad de sus colores y formas permiten hacer múltiples composiciones en paredes. Fabricados en plancha de acero pintada, o combinado con frontal de acabado roble mate. Tienen un sencillo sistema de fijación, ya sea anclado a pared o magnético.*

Pointo by  
STC Studio

## Pointo

*¡Encuentra las cosas que conectan contigo!*

# Find the things that connect with you!

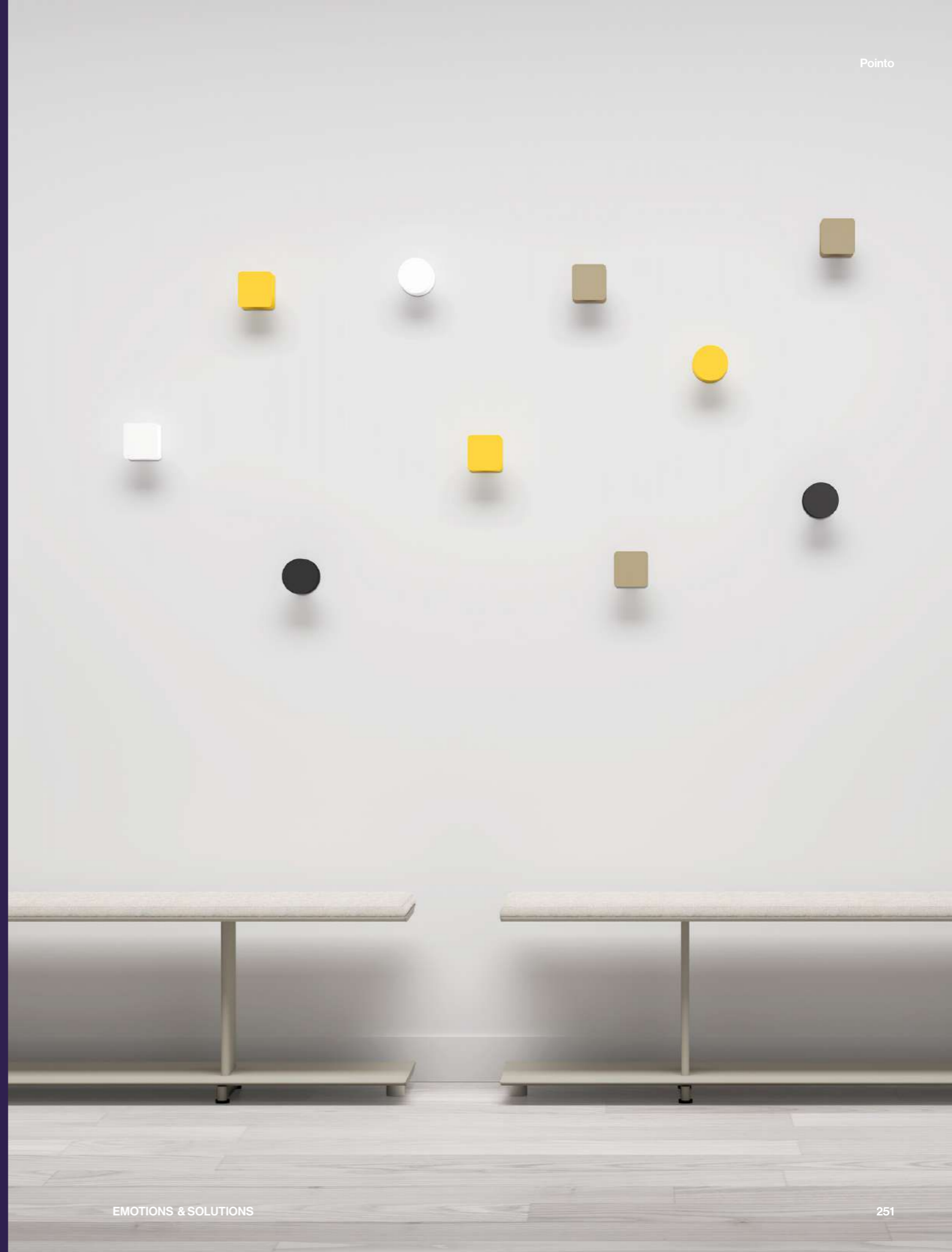

# Pointo



Pointo by  
STC Studio

## POCUA squared · cuadrado

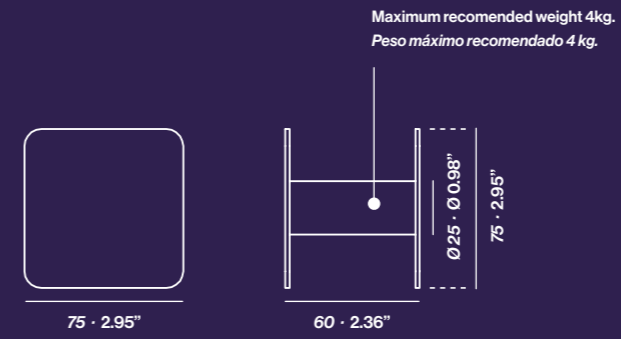

## POCUAM

Hanger with magnetic fixing system for metallic surfaces.  
Colgador con sistema de fijación imantado para superficies metálicas.

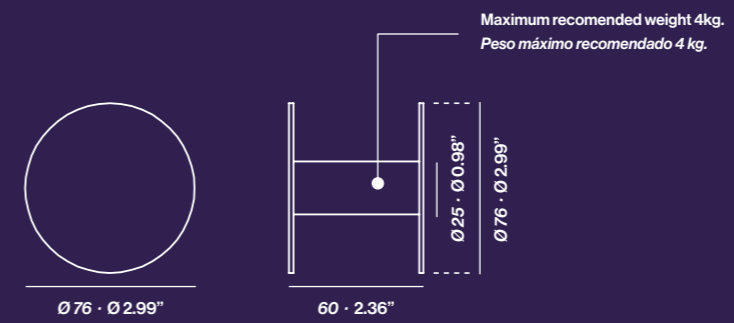
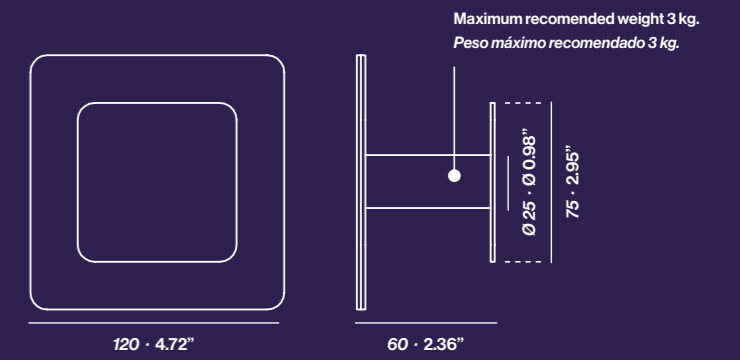

mm · inches

# Pointo

EN Wall hangers made of folded and painted steel sheet. Its design makes it an interesting, functional and decorative element.

ES Colgadores de pared fabricados en plancha de acero plegada y pintada. Su diseño los convierte en un interesante elemento a nivel funcional y decorativo.



Buraco by  
Aranda Aloy Enblanc

## Buraco

¿Puedo dejar mi bolso y llevarme el Buraco?

# Could I leave my bag and take the Buraco with me?

### BURACO

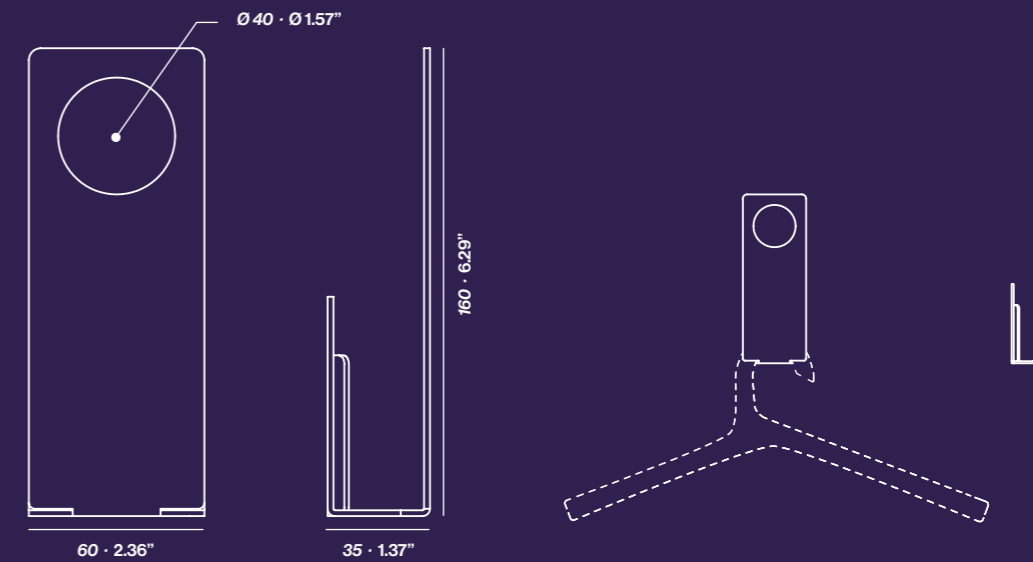

Maximum recommended weight 4kg.  
It allows hanging conventional hangers.

Peso máximo recomendado 4 kg.  
Permite colgar perchas convencionales.

mm · inches

## Buraco



**It's up to you  
what happens now...**

*Tú decides qué pasa ahora...*

# Our finishes!



# Other finishes!

EN Specific finishes per product reference as defined in the price list. ES Acabados específicos por referencia de producto definidos en tarifa.



Metallic finishes  
Anodized aluminum



Metallic finishes  
Sandblasted aluminum



Metallic finishes  
Natural aluminum



Metallic finishes  
Chrom-plated steel



Textured  
gold Karkar



Leatherette cone pouf  
Off white



Leatherette cone pouf  
Black



Leatherette cone pouf  
Beige

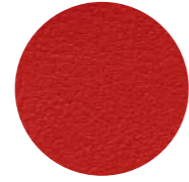

Leatherette cone pouf  
Red

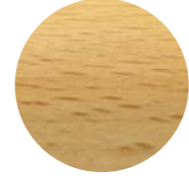

Wood  
Beech wood



Wood  
Matte oak



Nube clock finishes  
White

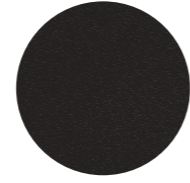

Nube clock finishes  
Black



Nube clock finishes  
Matte oak



Laquered MDF tabletop  
White



Laquered MDF tabletop  
Black



Melamine chipboard  
tabletop  
White soft

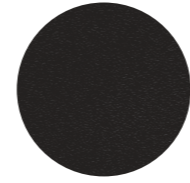

Melamine chipboard  
tabletop  
Black soft

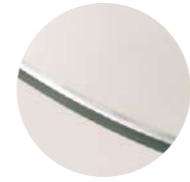

Glass tabletop  
Tempered glass



Outdoor version:  
HPL tabletop  
White soft

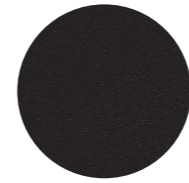

Outdoor version:  
HPL tabletop  
Black soft



Mathacrylate  
White



Mathacrylate  
Black



Mathacrylate  
Ice

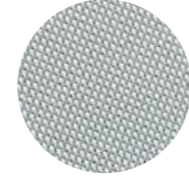

Screen fabric  
Light grey

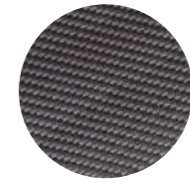

Screen fabric  
Anthracite gray



Tensabarrier tape  
Black

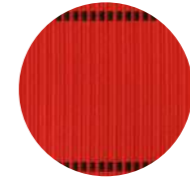

Tensabarrier tape  
Red

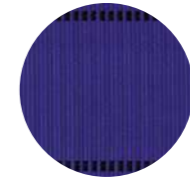

Tensabarrier tape  
Blue

Quality

ASSOCIATED N°00320  
**AIDIMME**  METAL-PROCESSING, FURNITURE, WOOD AND PACKAGING  
TECHNOLOGY INSTITUTE

 **Quality Controlled**

 **Systemtronic cares about the environment**

Credits

**EN** This publication may not be reproduced in whole or in part in any manner whatsoever without the written permission of the publisher. All models are protected by international patent.

**ES** *Esta publicación no puede ser reproducida en todo o en parte sin el permiso escrito del editor. Todos los modelos están protegidos mediante patente internacional.*

**Art direction**  
*Ana Ramón Estudio*

**Editorial design**  
*Ana Ramón Estudio*

**Photography**  
*Teddy Hernández*  
*Antonio Perpiñán*  
*La Galería Estudio*  
*Eduardo Corzo*

[www.st-systemtronic.com](http://www.st-systemtronic.com)  
*C/ del Mar 3 | Rafelbunyol*  
*Valencia | Spain*  
*Tel. +34 961 852 784*  
[nacional@st-systemtronic.com](mailto:nacional@st-systemtronic.com)  
[export@st-systemtronic.com](mailto:export@st-systemtronic.com)

*Printed in October 2024*

Thanks

**nanimarquina**

**Blasco&Vila**

VIBIA

**MOROSO<sup>M</sup>**

STUA

**NIL**

**viccarbe**

  
**CAHH**

**GLAS**  
ITALIA



systemtronic

