

SLIDE

SLIDE

We Love

"A small star in the constellation of design, SLIDE continues the path started back in 2002, producing on the outskirts of Milan, furniture, lamps and accessories, the result of continuous functional, aesthetic, technological and environmentally friendly research. SLIDE's objective has not changed over the years, always faithful to the idea of offering furnishing and lighting solutions with color, joy and emotions. Each product, in its uniqueness, is designed to respond to a need and become an icon over time. Sustainability remains at the center of our thought, a dutiful responsible legacy for future generations.

Marco Colonna Romano



After more than twenty years in business, we have updated our catalogue starting with a word that is dear to us: LOVE, which in Italian is AMORE, like our iconic bench. A thought that pervades our entire production, love for doing, and doing well, love for our territory and the people that make SLIDE a pioneer in the processing of plastics in furniture every day. We create models, based on an initial project drawn up in-house or with internationally renowned designers, of furniture and lighting that make the places where our stories unfold more precious. Although still young, our story is that of a company born to create ideas and eureka moments that have since become our staples.

In 2002, Giò Colonna Romano founded SLIDE, wanting to create awe and wonder. The first eureka moment came even before the creation of SLIDE: simple shapes, like spheres and cubes, created with translucent materials, whose inner light bulb emits a uniform light that adds decoration. Simple yet magical. With thirty years of knowledge of plastic materials, we pushed ourselves further to unleash the full potential of rotational moulding, and this led to our second eureka moment of luminous furnishing, which soon became a must-have in the event industry. All of this has led SLIDE to become well-known all around the world.

Throughout its history, SLIDE has been able to grow, innovate and stand out, offering complete furnishing for outdoors and for illuminating large spaces, residential and contract projects, but also small leading products for the home. With the generational change that began in 2015, Marco Colonna Romano, supported by a young, passionate team, transformed SLIDE into a designer brand for all intents and purposes, expanding the offer and combining the typical colourful pop products with an increasingly wide-ranging, refined line able to satisfy the tastes of architects and ideal for the hotel and contract sectors.

The resulting image is that of a young, innovative company based on sound principles since its inception: the high quality of Made in Italy and the continuous pursuit of excellence in rotational moulding technology. Playful shapes and colours are complemented by other materials, new tactile textures and shades and nuances that only SLIDE can create. Still deeply rooted in its birthplace – in Buccinasco, on the outskirts of Milan – where the offices and production hub are located, SLIDE has made a name for itself and its products in more than 130 countries around the world.



WE LOVE MAKING



Birth of Jumbo Bar, the first illuminated furnishing that becomes extremely popular for events and thus a distinctive trademark of SLIDE.



Paola Navone designs the Low Lita collection for SLIDE. Karim Rashid's Konkord stool wins the Good Design Award.



Introduction of soft polyurethane collections, expanding the product range for contract orders. Presentation of Marc Sadler's Kami furnishing collection.

FOUNDING OF SLIDE with the intention of entering the world of Design. The architect Guglielmo Berchicci is the Art Director and designs the first products, still in the catalogue today.



Giò Colonna Romano design AMORE bench, very soon becoming a worldwide timeless icon.



Issue of the first sustainability report. Ambrogio service table by Favaretto&Partners is already a best-seller and the first product made of second-life plastic.



New collaboration in the art sector, launching Bunny, designed by the Japanese designer Aki Kuroda and curated by Yoyo Maeght.

Launch of AMORE OCEAN made from ropes and nets collected from the Ocean.

1998 — 2002 — 2005 — 2006 — 2007 — 2009 — 2011 — 2013

Giò Colonna Romano creates and produces the first luminous geometric shapes Globo and Cubo destined for use in gardens.



Participation in the Abitare il Tempo and Light & Building trade shows. Participation in the Euroluce trade show.



Opening of the SLIDE EVENTS division and first partnerships with internationally renowned designers. Marcel Wanders designs the Chubby Collection for SLIDE.



Creation of the SLIDE ART Collection and participation in the Biennale di Venezia. Opening of an internal painting line to offer lacquered products for the indoor market for a higher range of customers.

2014 — 2015 — 2019 — 2021 — 2022 — 2023 — 2024 — 2025

Acquisition of the Design of Love collection and subsequent expansion.



Our concept "Contemporary Tradition" comes to life thanks to the collections designed by Lorenza Bozzoli, Fabio Novembre and Roberto Paoli. In this way, the industrial production and the craftsmanship get closer.

Our president & founder, Giò Colonna Romano sadly passed away. Its legacy of innovation, colors and happiness is forever engraved in SLIDE DNA



Presentation of Banana Leaf lamp designed by Marcantonio and part of Afrika Collection



We Love ITALY



Right from the outset, one of our goals has been to bring the quality, creativity and culture of Made in Italy design all around the world, using a material that allows us to show our full potential: low-density polyethylene, processed employing a method that aims to minimise partially harmful emissions. Thanks to the collaboration of all divisions with the research and development department, over the years, we have managed to combine the spirit of craftsmanship with industrial processing. A line was therefore created where nuances and finishes become

unrepeatable and every product is therefore unique. We want our Made in Italy design to be an ethical choice, where ideas and their creation take place all in the same building. Choosing a SLIDE product means choosing a sustainable design and putting beauty and quality within everyone's reach.

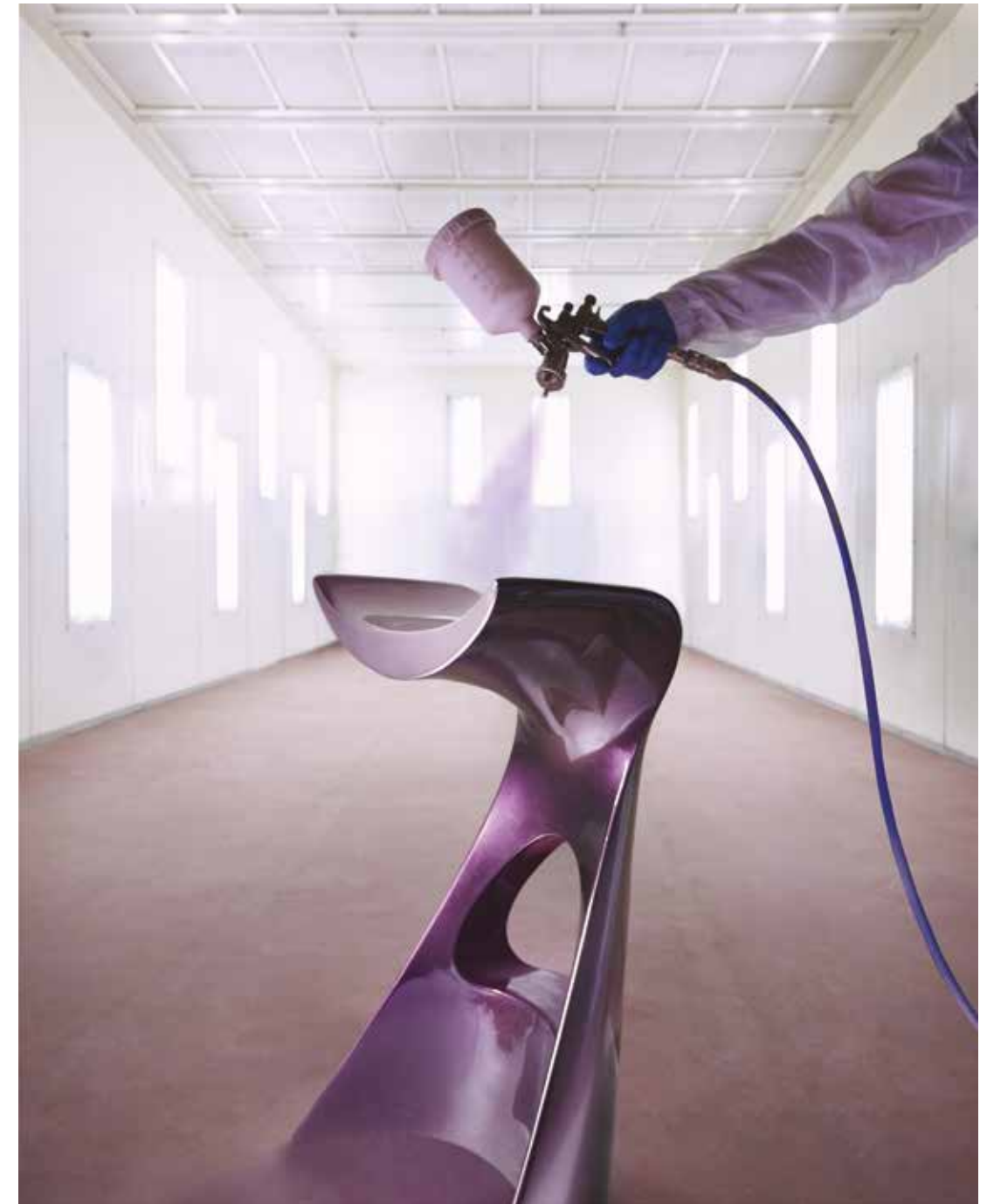

We Love SUSTAINABILITY



From Bioplastic Sugarcane



Recycled Polyethylene



From Ecoallene Tetra Pak

Our production is entirely carried out with a view to the ethical path of a circular economy. This starts with our rotational moulding technology, which minimises any potentially harmful emissions and has a low environmental impact. Furthermore, thanks to the installation of solar panels on our warehouses, we have made a real turning point in the use of renewable resources that make the company even more independent in terms of energy.

Made from 100% recyclable polyethylene, at the end of their lives, our products are returned to plastic powder, ready to be used for other 100% recycled furniture, particularly in Jet Black colour. Recycling also creates the most refined part of our collection, through product lacquering, the jewel in our crown. Painting the surfaces of our products helps cover up any scratches or small imperfections that might appear during production and therefore to salvage them into much finer objects, with the same resistance as all the others.

Thanks to our Research and Development department and our suppliers, we have added new, more ethical and durable raw materials. In fact, Ambrogio, Amanda and Together are made with a new plastic, Geco, with 30% EcoAllene, a material entirely recycled from Tetra Pak cartons, which would otherwise be sent to incinerators. The Afrika collection, with its more textured colours, is made from bioplastic, a new material made from natural sugarcane fibres. AMORE OCEAN is also made in a second life plastic thanks to ropes and nets collected from the Ocean. In our collections, we wanted not only to look at the aesthetics of the product but also at the beauty of our surrounding world, which we want to preserve thanks to a low environmental impact.

Recycled Polypropylene
From Marine Ropes



Recycled Polyethylene
From Fishing Nets

We Love DESIGN



ALVARO URIBE



GIÒ COLONNA ROMANO



FABIO NOVEMBRE



ROBERTO PAOLI



STEFANO GIOVANNONI



MARTINELLI VENEZIA STUDIO



ITALO PERTICHINI



MORO & PIGATTI



LORENZA BOZZOLI



MARCEL WANDERS



LANZILLO & PARTNERS



AKSU & SUARDI STUDIO

The strength of our products also comes from our collaboration with some of the brightest minds on the international design scene. Over the past twenty years of business, our catalogue has grown together with them.

Many names have joined our family: we have worked with about forty creatives from all around the world, some of them are already well-known, while others are very promising young talents.

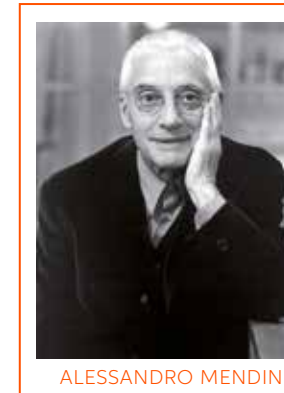

ALESSANDRO MENDINI



AKI KURODA



ADRIANA LOHMANN



MARCANTONIO



PAOLA NAVONE



GUGLIELMO BERCHICCI



KARIM RASHID



FAVARETTO&PARTNERS



GIANNI ARNAUDO



MARC SADLER

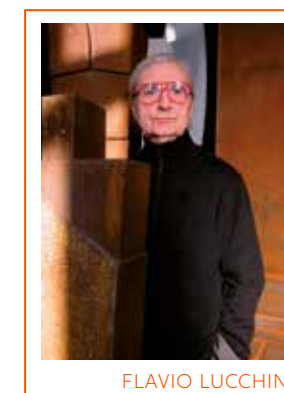

FLAVIO LUCCHINI



GIULIO CAPPELLINI

We Love ART



CHRISTIE'S CHARITY AUCTION
DESIGNER'S DREAM – SUPERSTUDIO PIÙ 2024

SLIDE Art is a sculpture project where Art and Design meet, combining their main special features: Design becomes higher conceptually, while Art becomes serially reproducible, in a limited number.

Thought and creativity therefore meet Italian craftsmanship, creating a new concept of Art, which shapes the material and turns it into sculptures produced in limited, numbered and certified pieces.

SLIDE Art is a hotbed of ideas where designers and artists can experiment with shapes, materials and concepts, supported by the expertise, knowledge and experience developed by SLIDE, in a dialogue that can combine a single work from two core elements, that of Design and Art, which are so similar yet so different. Alessandro Mendini, Karim Rashid, Anna Gili, Sacha Sosno, Jean Claude Fahry, Flavio Lucchini and Ben Vautier are just a few of the illustrious names that have taken part in the project.



KARIM RASHID - TWIST, 2011



ALESSANDRO MENDINI - FOUR, 2021
LIMITED EDITION IN 8 PCS. - SLIDE FOR ALESSANDRO MENDINI. COSE

We Love HOSPITALITY



HOTEL INDIGO - MILAN (ITALY)

Over the years, we have improved the comfort, along with the uniformity of light and the ergonomics of our products. We have therefore developed increasingly advanced furniture, we have played with textures and nuances capable of embellishing polyethylene, and we have researched into elements and accessories that would make our products really refined goods.

We have perfected our lights, so they can create even more striking atmospheres. This results in a range of complete furniture for every type of indoor and outdoor contract project.



FRESH HOTEL - ATENE (GREECE)



BOUDICA RESTAURANT - LONDON (UK)



GIALLO MARE BEACH - VIAREGGIO (ITALY)

We Love CUSTOM PROJECTS

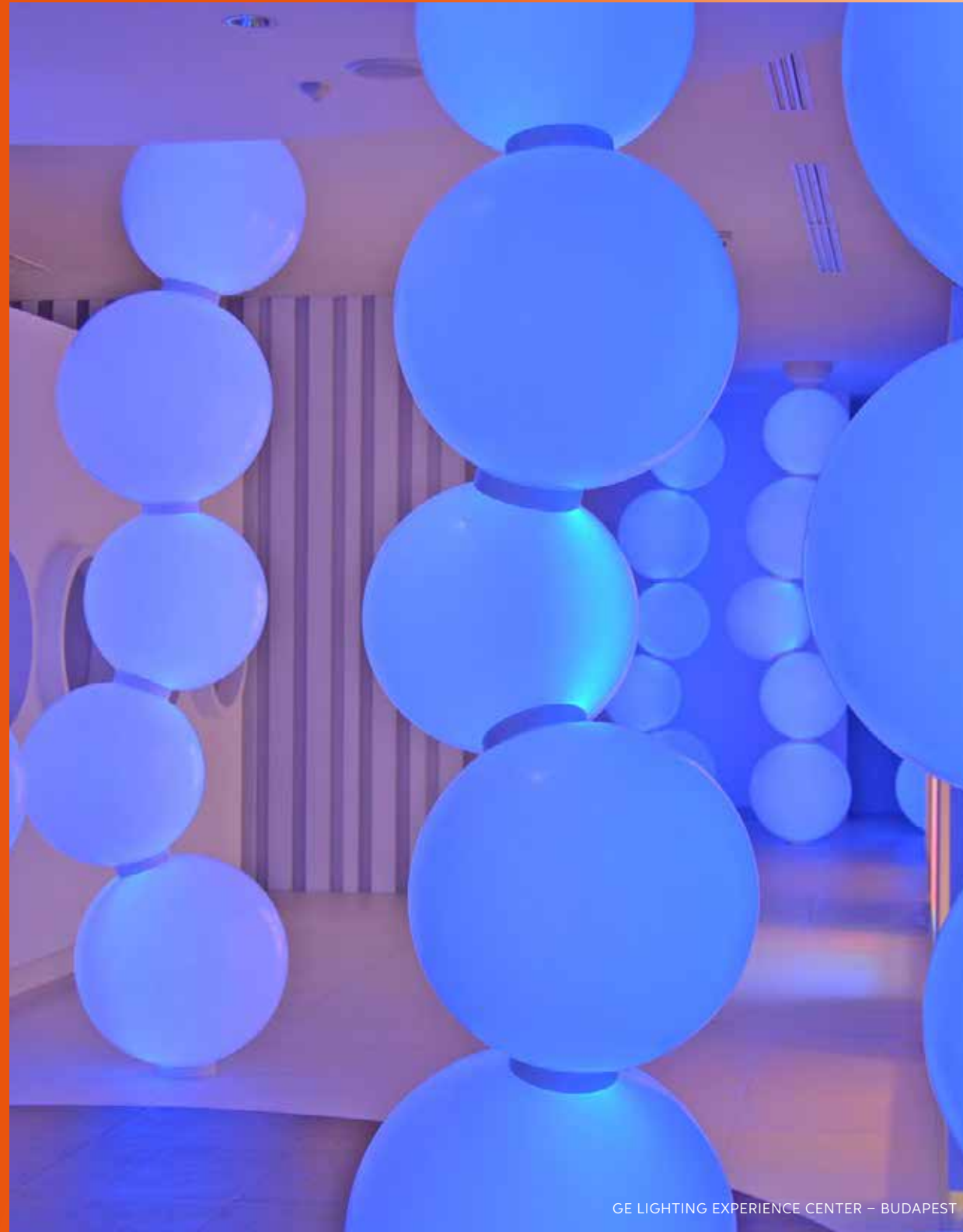

Magic and awe are encapsulated in lightweight, resistant furniture that is easy to move. From a desire to ensure that every layout is unique and unforgettable comes the possibility of adjusting and customising our furniture with your logos, colours and accessories.

Over the past 20 years, we have been part of so many installations, which have led us to celebrate private and corporate events with you and to furnish your displays. We could not be happier when seeing you spend memorable moments accompanied by our furniture.



We Love EVENTS



Always at the side of designers, professionals, and private clients, SLIDE stands for creativity and originality in furnishing for unique and unforgettable events. Our furniture, especially our luminous pieces, is the perfect ally for creating stunning, scenographic setups.

With a wide range of versatile and customizable products, SLIDE can transform any space into an emotional experience. From retail displays to hotel and restaurant spaces, and even outdoor environments, our furniture provides that “wow factor”

that leaves a lasting impression. Thanks to the lightness and durability of our materials, SLIDE's solutions are ideal for those seeking easy-to-manage installations with a powerful visual impact. We are ready to collaborate with designers and event planners to create events that blend style, functionality, and luminous magic, providing tailor-made solutions for every need.



We Love HAPPY MOMENTS



#IRONY



#WONDER



#DREAMTEAM



#PLAYTIME



#HAPPINESS



#SUMMER



#SPIRITUAL

Sharing your precious moments with us is what makes us proud of what we do. We like to think that all of our products are more than just objects, seeing them as inhabitants of a world that we share and that we can help change through our behaviours and habits.

We are happy when you manage to improve your surrounding world, together with one of our products: durable, sustainable and lovable. Thank you to everyone who has chosen us.



#EMOTIONS



#FUN



#FROMTHETOP



#FAMILY



#COMPLICITY



#RELAX

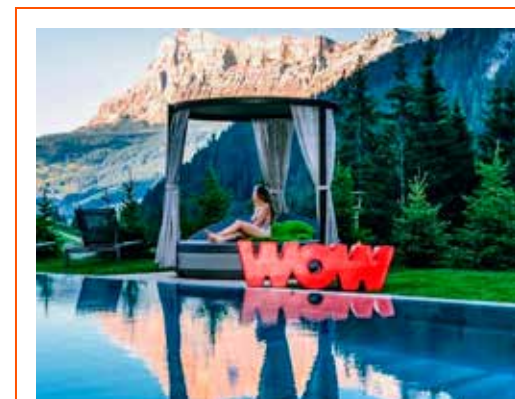

#PEACE



#FRIENDSHIP

We Love ICONS

Over the past twenty years, we have created objects with a unique design to make your spaces unforgettable. Six ways to be different, each with its own unique nature.

BE A MESSAGE
BE GLAMOUROUS
BE POP
BE COLOURFUL
BE BRIGHT
BE MERRY

BE A MESSAGE

An object, an affordable, accessible piece for everyone, carrying a universal message: the message of love. With this creation, SLIDE introduces a revolution in its design approach, bringing high-quality design into a smaller, more approachable size and price. amore message is self standing, and can be positioned over a shelf, a desk, a frame or many other places.



BE GLAMOUROUS

For contemporary spirits, but with a more distinguished look. Our lacquered products add a glamorous, refined taste to any indoor and outdoor space, thanks to their elegant surfaces and sophisticated, customisable colours.



1. IL VASO pot | p. 254
2. HERE table lamp | p. 162
3. MINERAL STAND floor lamp | p. 124
4. MIRROR OF LOVE size L mirror | p. 240
5. MIRROR OF LOVE size XL mirror | p. 240
6. AMBROGIO servant table | p. 226
7. AMANDA servant table | p. 228
8. LADY OF LOVE table lamp
9. AMORE bench | p. 220
10. MINERAL STAND table lamp | p. 124
11. DUKE OF LOVE coffee table
12. CUBIC YO pot | p. 265

BE POP

If you love unusual shapes and colours, our pop style will brighten up any environment. With their vibrant colours and exciting design, our products are ready to turn into the perfect element to stand out, to send a message or for a unique touch.



- 1. **GEAR** stool, coffee table | p. 100
- 2. **DOUBLE U** stool | p. 100
- 3. **ICO** hanging lamp | p. 165
- 4. **SUNDAY** hanging lamp | p. 165
- 5. **JUXT** hanging lamp | p. 165
- 6. **TOY** coffee table | p. 100
- 7. **MYBOOK** bookcase | p. 255
- 8. **WOW** bench | p. 220
- 9. **FLUO** floor lamp | p. 164

BE COLOURFUL

For the more extravagant, designers from all over the world have given free rein to their imagination. Featuring many bright colours or more natural shades, our colourful side is ready to amaze even the most creative characters.



1. **FLUX** floor lamp | p. 132
2. **CUPOLE** hanging lamp | p. 138
3. **KONCORD** high stool | p. 200
4. **JET** table | p. 200
5. **GELEE** soft pouf | p. 94
6. **MR. GIÒ** valet | p. 263
7. **MR. GIÒ SPECCHIO** mirror | p. 263
8. **ELIOS** hanging lamp | p. 137
9. **MAG** magazine rack | p. 262
10. **THREEBÙ** stool, coffee table | p. 42
11. **LOW LITA** low chair | p. 68
12. **OTTOCENTO MINI size L** coffee table | p. 50
13. **OTTOCENTO MINI size M** coffee table | p. 50

BE BRIGHT

Small objects, big players. Our table lamps are a smaller size but have a big personality, capable of surprises. Thanks to their unusual appearance, they are ready to become the perfect companions for the home and beyond.



1. LUNA table lamp | p. 144
2. PRÊT-À-PORTER table lamp | p. 163
3. PUPA table lamp | p. 150
4. LOVE table lamp | p. 163
5. KOKÔ table lamp | p. 162
6. PURE table lamp | p. 163
7. JUMPIE table lamp
8. JUNIOR table lamp
9. GLOBO table/floor lamp | p. 120
10. OTELLO MINI table lamp
11. CARMEN table lamp | p. 162
12. BUBO table lamp
13. CUBO table/floor lamp | p. 161

BE MERRY

The joy of winter festivities overflows thanks to furniture items and accessories that can create the perfect atmosphere for displays, homes, restaurants and hotels. For anyone who loves winter, here are our reinterpretations with a contemporary, pop twist of the symbols we all know and love.



1. SIRIO hanging lamp
2. MERRY CUBO table/floor lamp
3. FIAMMETTA / FIAMMA table lamp | p. 163
4. LIGHTTREE table/floor lamp | p. 164
5. KOLME table lamp | p. 163
6. KUUSI table lamp | p. 163
7. PANDORO stool

We Love
FURNITURE



COLISEUM

Design
ALVARO URIBE

category **armchair**
material **polyethylene**

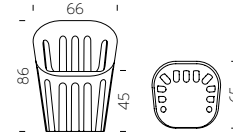

History becomes function in the Coliseum chair. Inspired by the iconic architecture of the Rome Colosseum, this chair reverently honors its majestic arches and grandeur. Its monolithic body is punctuated by multiple arches, infusing the chair with a sense of timeless lightness. With its iconic grooves, the chair artfully plays with light and shadow, transforming any space into a mesmerizing showcase of splendor and light patterns.



*Good Design
Award 2024*

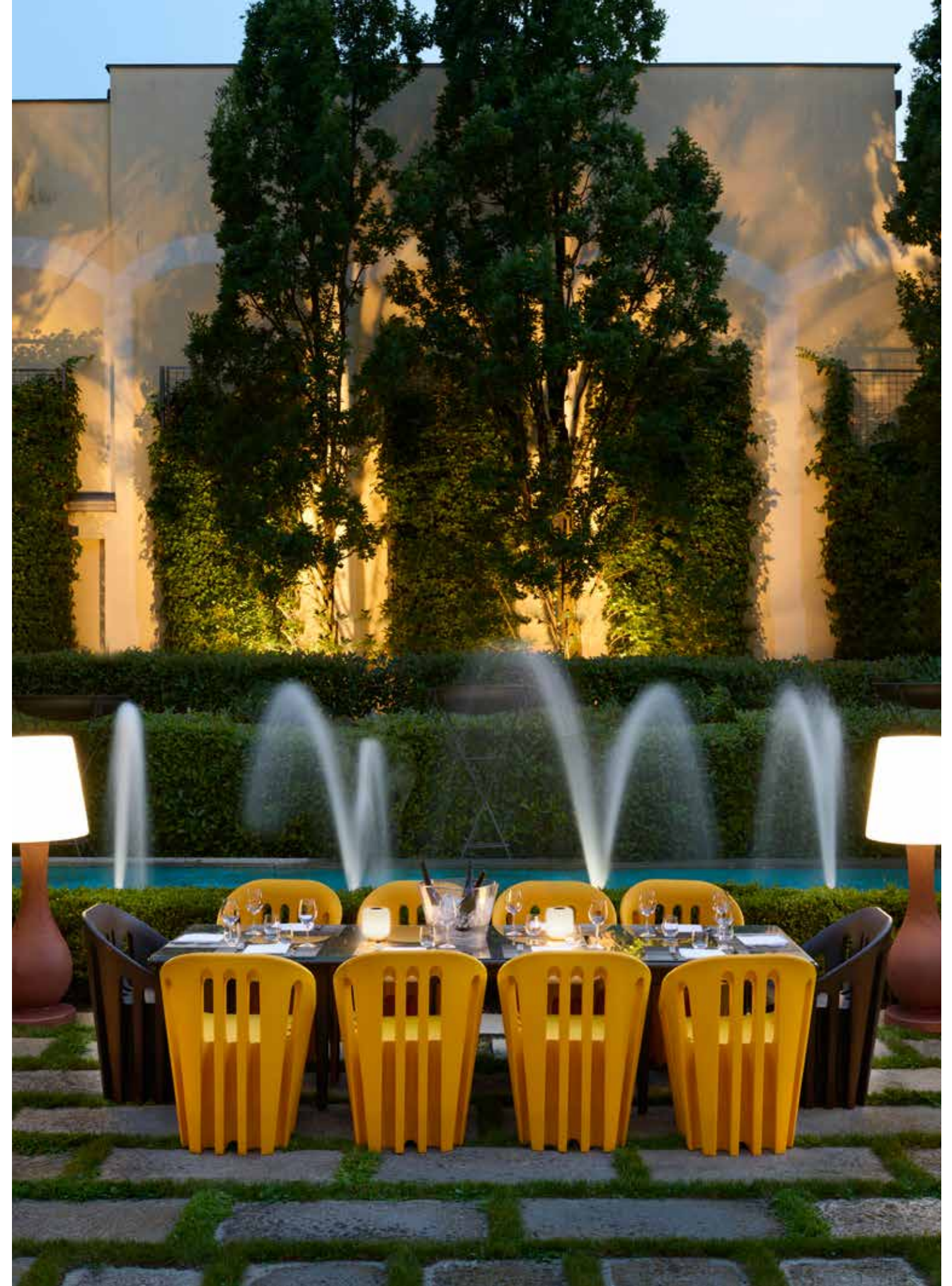



AFRIKA COLLECTION



Design
MARCANTONIO

Collection
KROKO
BIG KROKO
THREEBÙ
THREEBÙ POT
THREEBÙ TOTEM



Good Design
Award 2023



Archiproducts
Design Awards
2023

A distant and iconic world becomes contemporary and close to us thanks to the most serious characteristic of all: irony. Marcantonio's unmistakable style signs Afrika collection: the Kroko chairs and the Threebù items.





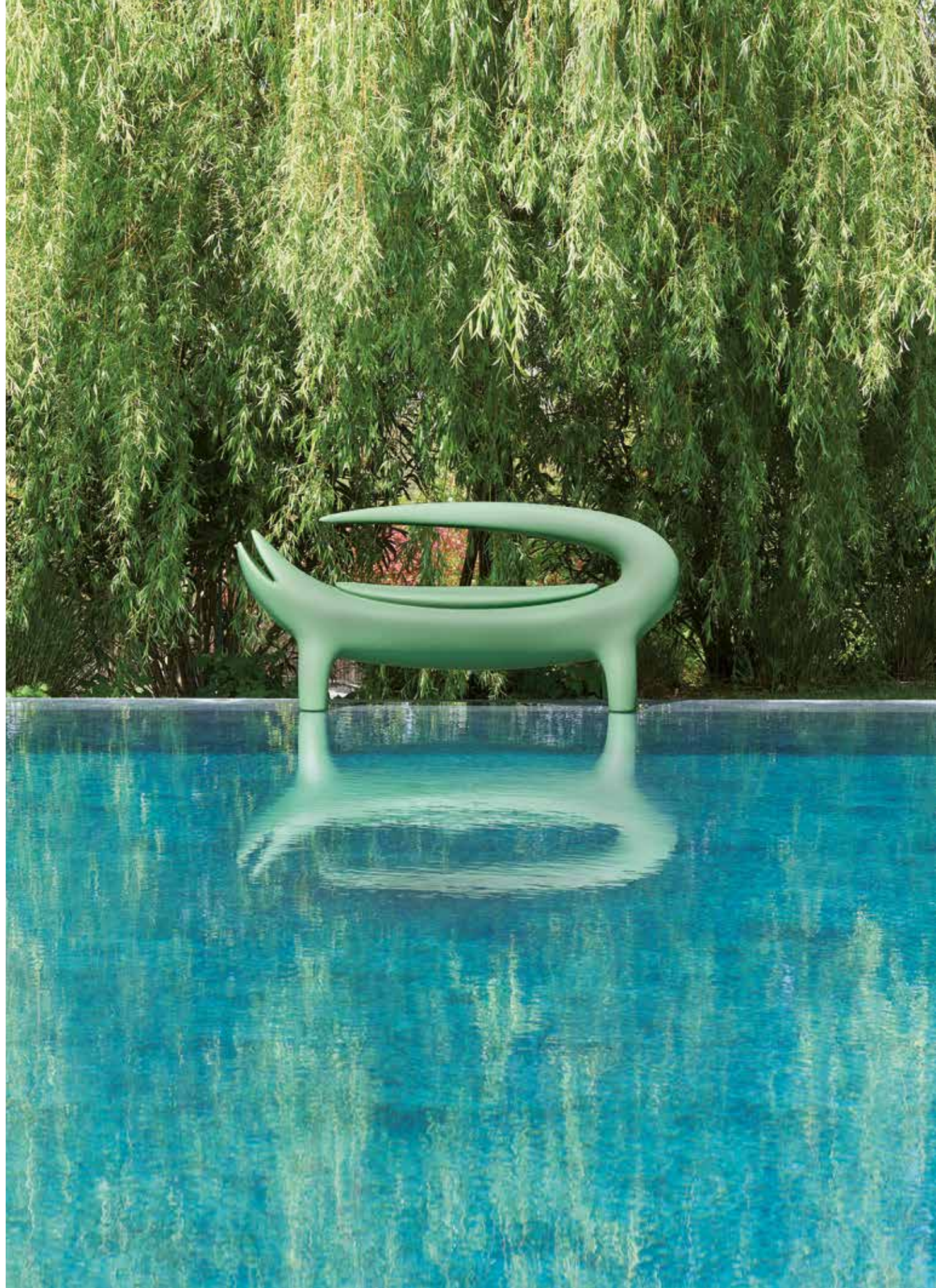

"Kroko is at the same time an industrial item and a sculpture, with references to Nature and contemporary art, thanks to its hinted but also unmistakable shape".
Marcantonio

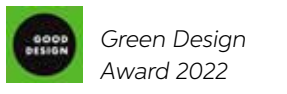



AFRIKA COLLECTION

category armchair, bench, stool, pot, floor lamp
material polyethylene



KROKO



BIG KROKO

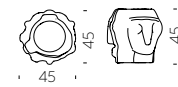

THREEBÙ

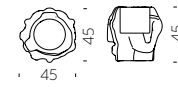

THREEBÙ POT

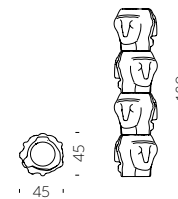

THREEBÙ TOTEM



OTTOCENTO COLLECTION



Design
PAOLA NAVONE - OTTO STUDIO

Collection
OTTOCENTO SIZE M
OTTOCENTO SIZE L
OTTOCENTO MINI SIZE M
OTTOCENTO MINI SIZE L
OTTOCENTO UP



Good Design
Award 2019

"Inspired by the shapes of Neoclassicism, the purity of the material is linked to the classic nature of the shapes, which remind of the luxury of marble and the elegance of dark colours".

50 Paola Navone







OTTOCENTO COLLECTION

category **table, coffee table**
 material **polyethylene,**
HPL tabletop

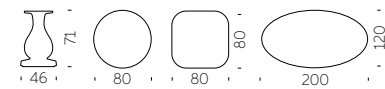

OTTOCENTO SIZE M

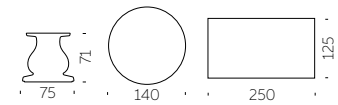

OTTOCENTO SIZE L

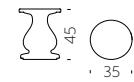

OTTOCENTO MINI SIZE M

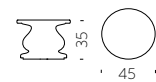

OTTOCENTO MINI SIZE L



Ottocento is an indoor and outdoor table available in five polyethylene base sizes, combinable with different shapes and finishes HPL tops. Thanks to a collaboration between the designer and SLIDE production department, every table is a unique piece.

OTTOCENTO UP



Design
PAOLA NAVONE - OTTO STUDIO

category high table
material polyethylene,
HPL tabletop

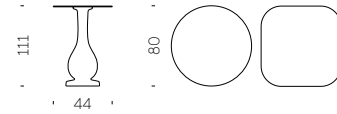

Inspired by the Neoclassicism artistic movement of the early 19th century Ottocento Up is the third creation of the tables collection designed by Paola Navone OTTO Studio. Ottocento Up is a tall table, ideal to be combined with the Ribs Up stool from the same collection, and it reminds of the refined neoclassical columns and is completed by an HPL top with natural textures and finishes like the other models in the collection.



RIBS COLLECTION



Design
PAOLA NAVONE - OTTO STUDIO

Collection
RIBS
RIBS UP

RIBS COLLECTION

category Armchair, high stool
material polyethylene,
galvanized metal



RIBS



Ribs and Ribs up, with their friendly and familiar design, have organic shapes but a strong and contemporary pop soul. Their essential elegance of the structure matches perfectly with the volumes typical of rotational moulding.



RIBS UP

Design
PAOLA NAVONE - OTTO STUDIO

category high stool
material polyethylene,
galvanized metal

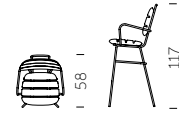

RIBS UP



MARA COLLECTION



Design
LORENZA BOZZOLI

Collection
MARA
MARA SOFA
MARA POUF
MARA LOW TABLE



"The woven leather comes to life in all the texture of the Mara collection structure to reproduce also on the plastic material the imperfect and tactile intertwining typical of leather hand manufacturing. The unique texture is combined with the soft cushions in waterproof fabric and suitable for outdoor use".



Good Design
Award 2019

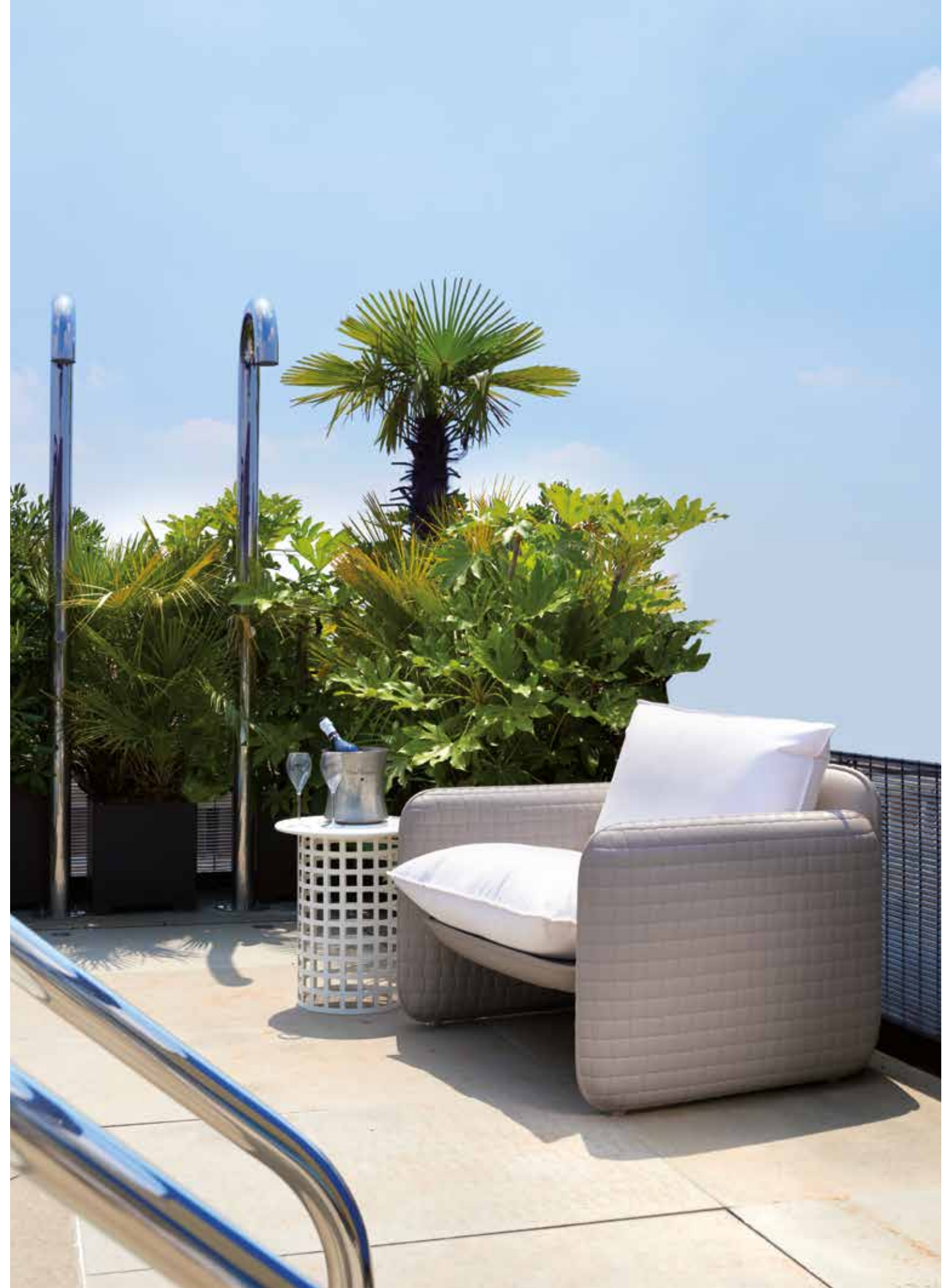



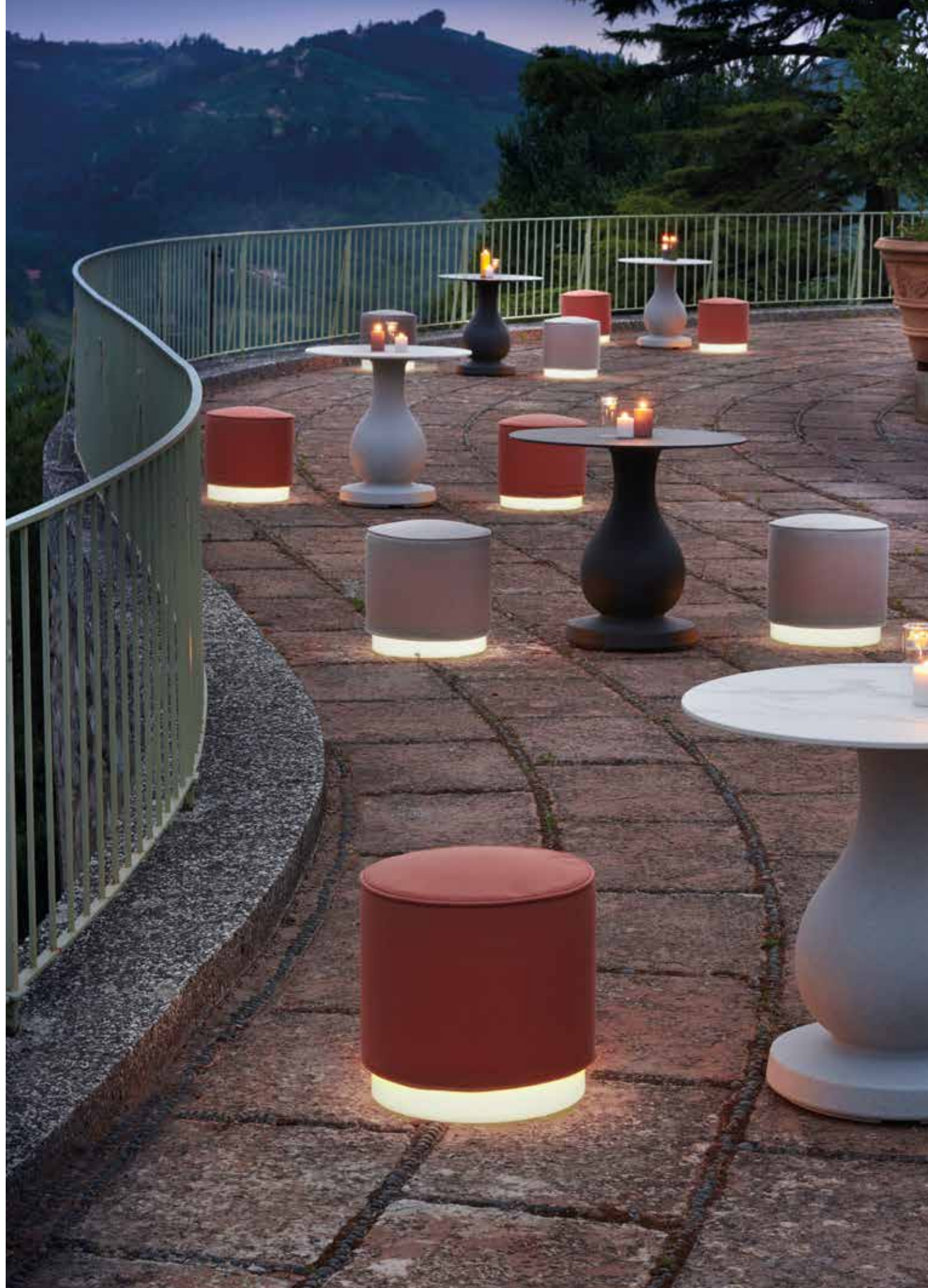

MARA COLLECTION

category Armchair, sofa, pouf, coffee table
 material Polyethylene, textile cushion (for seats)
 zinc-coated iron, hpl tabletop (for coffee tables)

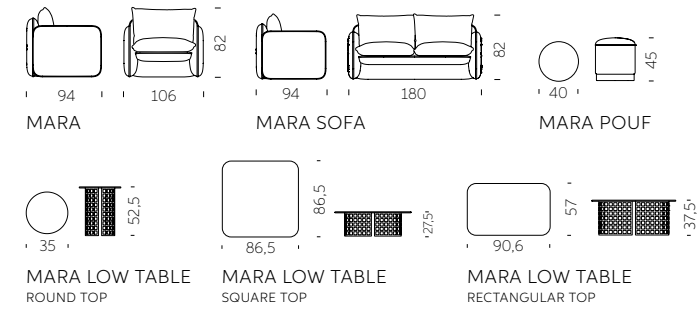

LOW LITA COLLECTION



Design
PAOLA NAVONE - OTTO STUDIO

Collection
LOW LITA
LOW LITA LOVE
LOW LITA LOUNGE
LOW LITA TABLE

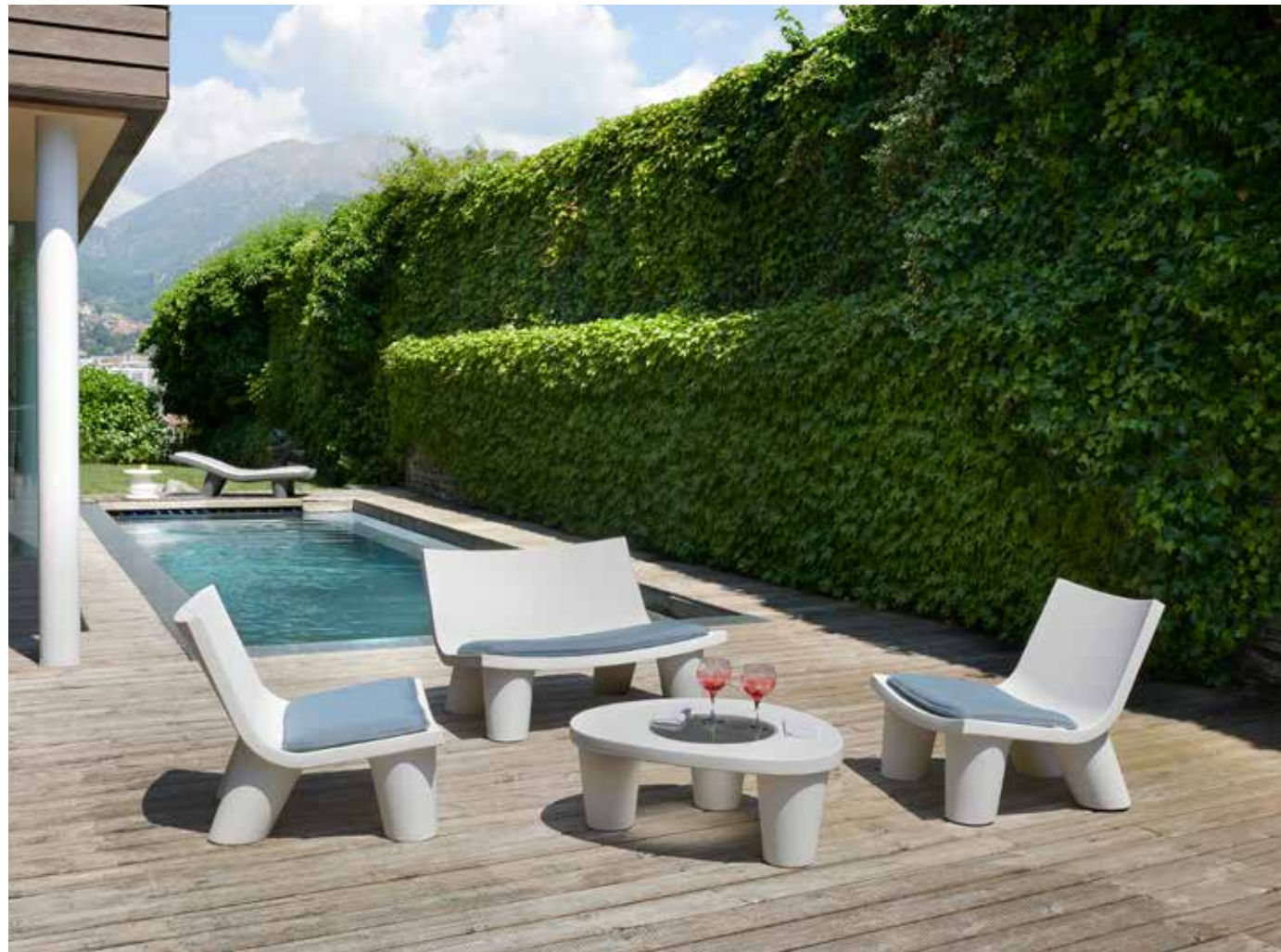

"This collection is dedicated to the pleasure of relax both outdoor and indoor, it looks informal, fun and nice. Low Lita collection tells stories of different worlds which "mix-up" with joy".

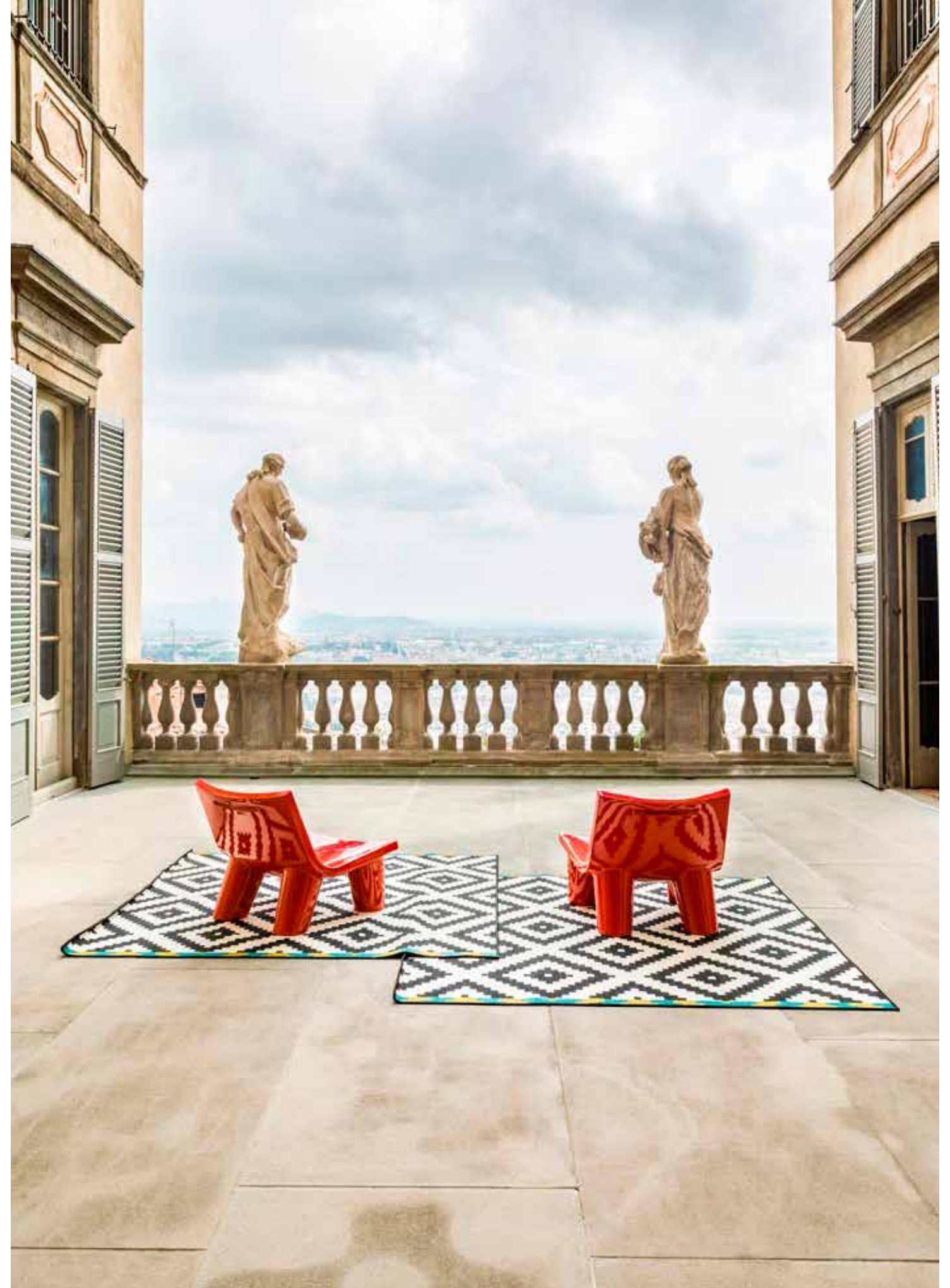



LOW LITA COLLECTION

category **armchair, lounge seats, sofa, coffee table**
 material **polyethylene, textile cushion**

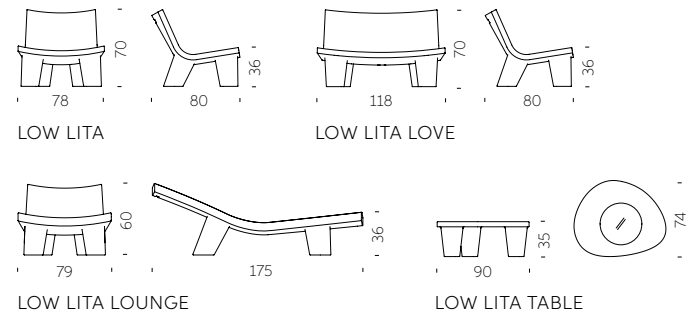

“Low Lita can remind of a seat with an African style of an exotic country. Unexpectedly, it becomes something different but also contemporary, thanks to its material and the technique used to realize it”.

Paola Navone





ANNIVERSARY EDITION

We celebrate the iconic Low Lita with a new nuance, born from the perfect match between Paola Navone's incredible creativity and the deep knowledge of Slide in the processing of plastic materials.

Low Lita Anniversary collection is not a special edition, but it is unique: its black and white nuances are the result of the craftsmanship of rotational moulding; these nuances are not replicable so to personalize each product.



QUEEN OF LOVE



Design
MORO & PIGATTI

category **armchair**
material **polyethylene**



"The Design of Love collection is completely Made in Italy and has brought a touch of freshness and an innovative approach to the design world by re-interpreting the Baroque furniture in a Pop way".



LITTLE PRINCE OF LOVE



Design
MORO & PIGATTI

category pouf
material polyethylene



LITTLE PRINCE OF LOVE / MORO & PIGATTI

WE LOVE FURNITURE

LITTLE QUEEN OF LOVE



Design
MORO & PIGATTI

category kids armchair
material polyethylene



Little Queen of Love is the smaller model for kids of the iconic Queen of Love armchair. The Baroque style of its shapes and the pop style of polyethylene make Little Queen of Love a small star in every room it occupies, for both contract and homes.



LITTLE QUEEN OF LOVE / MORO & PIGATTI

WE LOVE FURNITURE



Design
MARTINELLI VENEZIA STUDIO

category sun lounger
material polyethylene,
textile cushion

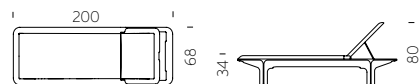

The perfect balance between soft shapes, typical of the creations obtained through rotational moulding, and thin thickness, which allows reducing the physical and perceptive weight of a large object. Elegant and cosy, thanks to the adjustable backrest in different inclinations, Ponente can be completed with a comfortable soft fabric cushion for outdoor.

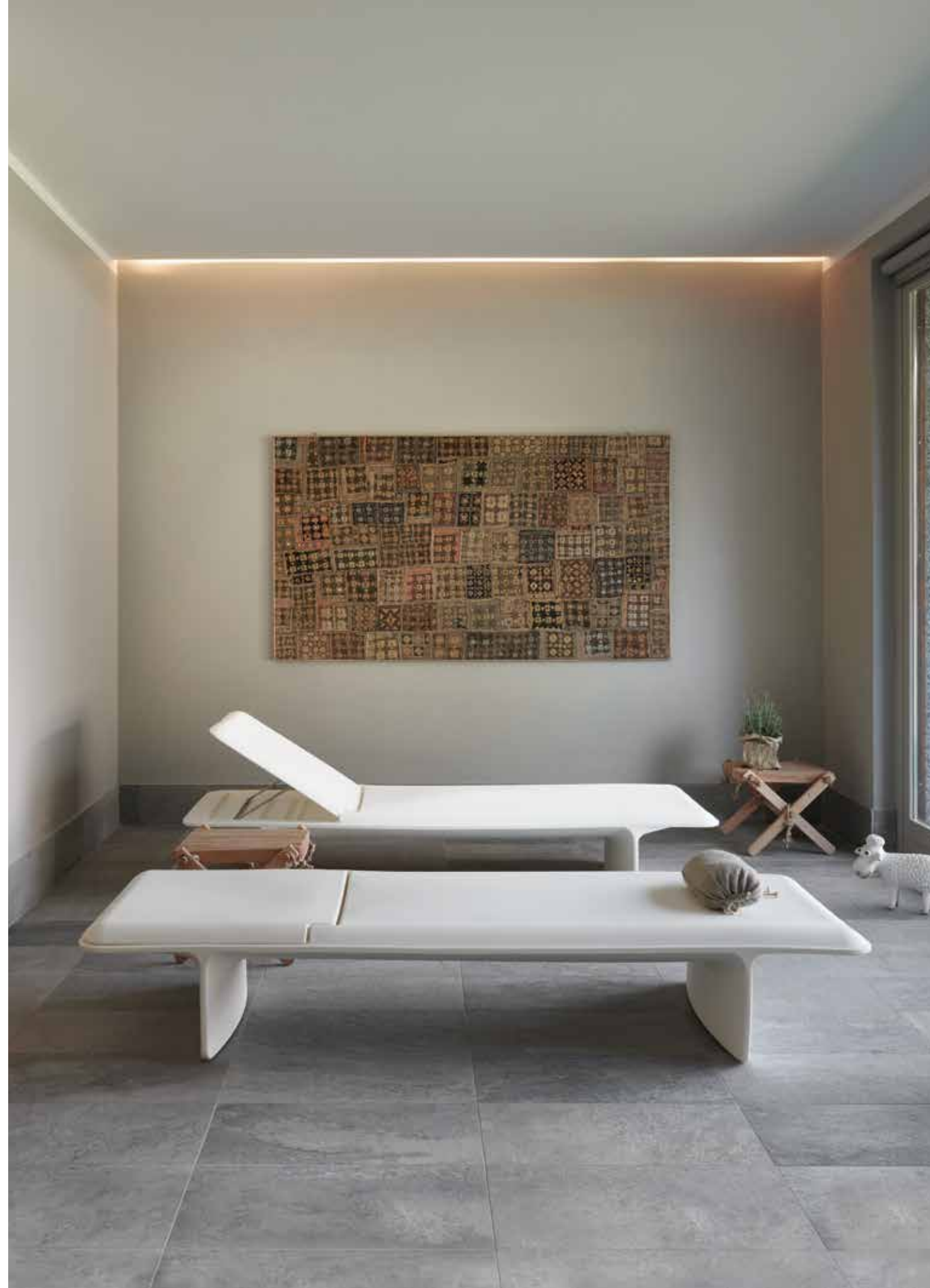

RAP COLLECTION



Design
KARIM RASHID

Collection
RAP CHAIR
RAP



Ideal to create unforgettable indoor or outdoor corners, the Rap collection is a magnet with its minimal but unusual design. The shape of the backrest embraces whoever sits on. The Rap collection gives comfort, relax and a sense of protection that allow you to enjoy a lovely moment.

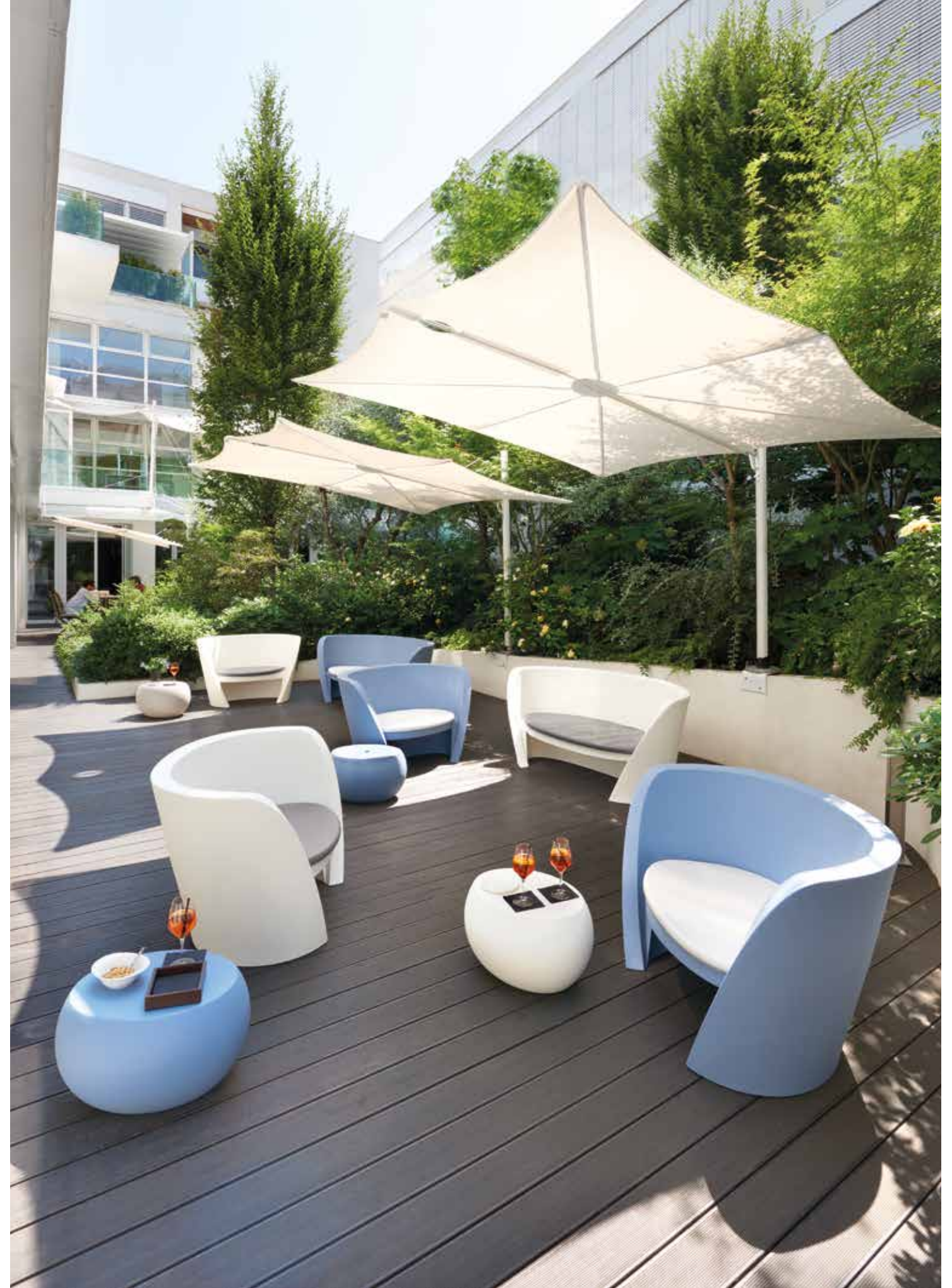

RAP COLLECTION

category **armchair, sofa**
material **polyethylene, textile cushion**

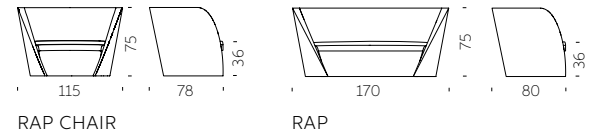

KAMI COLLECTION



Design
MARC SADLER

Collection
KAMI ICHI
KAMI SAN
KAMI YON
KAMI NI



“The name of the collection takes its inspiration from the ancient Japanese art of folding papers. The shapes traced by lines and bisectors characterizes the armchair and the sofa, as well as the seats with the related small table.”



BLOS COLLECTION



Design
KARIM RASHID

Collection
BLOS
BLOSSY
BLOS LOW TABLE
BLOS POT

BLOS COLLECTION

category armchair, sofa
material polyethylene

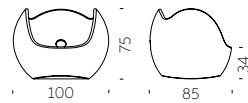

BLOS

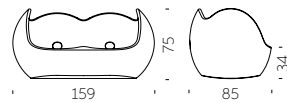

BLOSSY

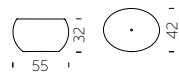

BLOS LOW TABLE

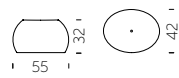

BLOS POT



"I always work with the strengths of a client. Slide's strengths lie in their joy for form and mastery of rotomolding. Blos collection comes from that gregarious and expansive personality. The round bulbous forms envelop those sitting and rock gently creating a positive cocooning feeling".



CHUBBY COLLECTION



Design
MARCEL WANDERS

Collection
CHUBBY
CHUBBY LOW
CHUBBY SIDE TABLE

CHUBBY COLLECTION

category lounge armchair, footrest,
coffee table
material polyethylene,
glass tabletop
(for coffee table)

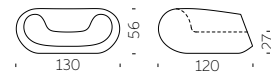

CHUBBY

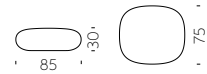

CHUBBY LOW



CHUBBY SIDE TABLE



"Chubby was projected as a plastic reinterpretation of the Crochet Chair, an armchair composed of crocheted fiber which has been hardened with epoxy and designed in a limited edition. The open structure and lightness of the chair provided a nice contrast".

90 Marcel Wanders

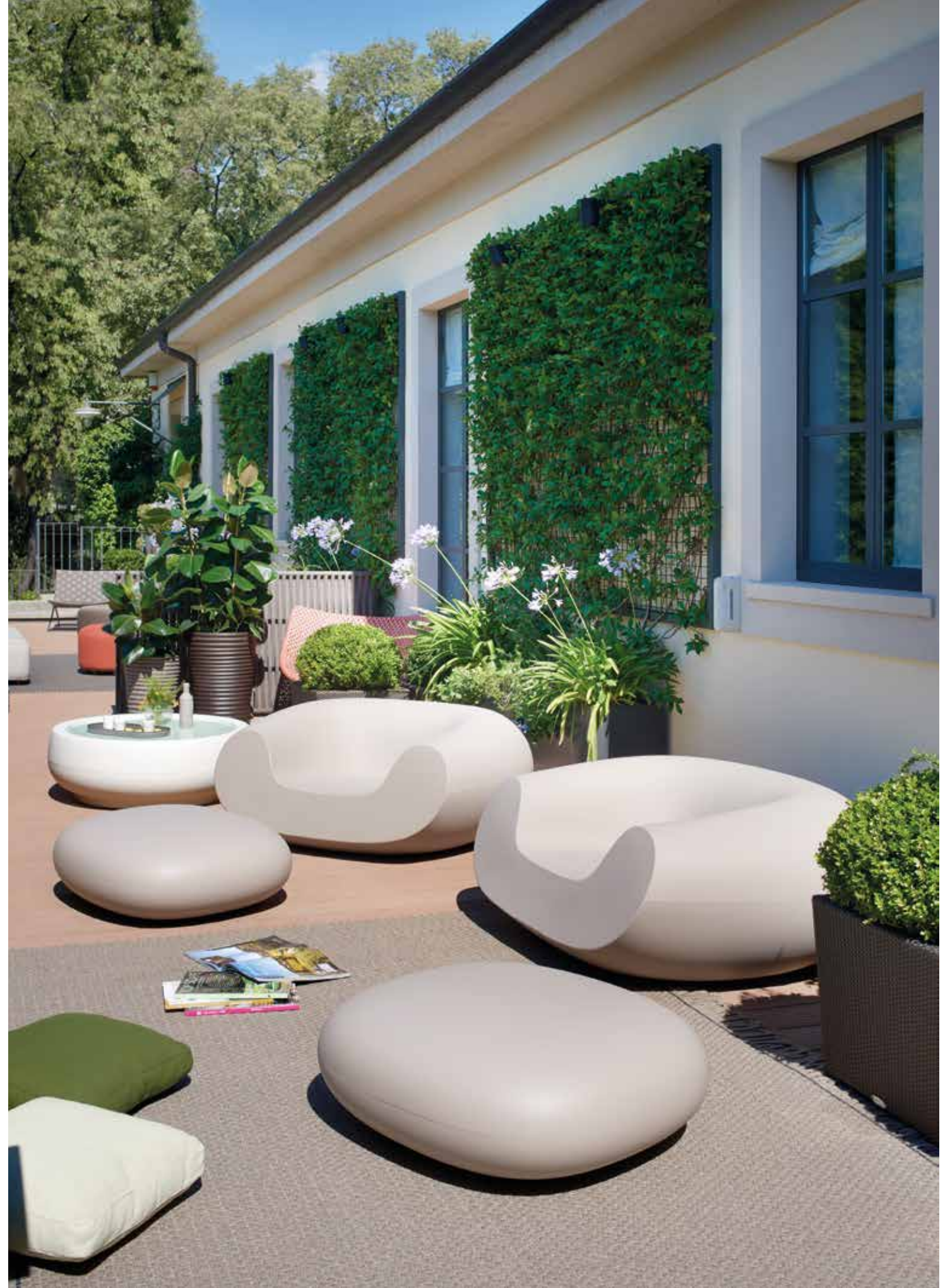

Design
BEDINI, MARZANO, SETTIMELLI

category sofa
material polyethylene,
textile, ecoleather cushion

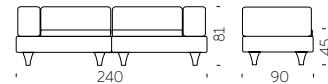

As a classic nineteenth-century lounge sofa, HappyLife has all the features of comfort and stability. Depending on the needs, it can be a useful flat surface or a comfortable sofa, thanks to the addition of padded cushions available in eco-leather or fabric, both waterproof for outdoor use.



GELÉE COLLECTION



Design
ROBERTO PAOLI

Collection
GELÉE
GELÉE GRAND
GELÉE LOUNGE



"Being inspired by jelly candies I designed Gelée, a soft and nice touch pouf, that converts a familiar product in something else, placed in a different context, made in new dimensions. The result is a comfortable seat which shape and colour immediately stimulates leisure, desire of touching and testing its comfort".



Gelée Lounge,
Good Design
Award 2018





GELÉE COLLECTION

category soft pouf, soft armchair
material soft polyurethane

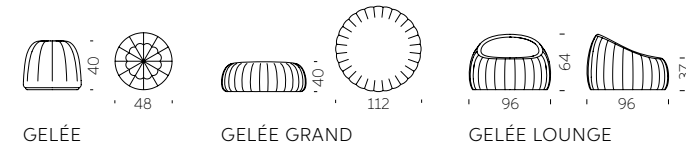

ED + ZOE



Design
GUGLIELMO BERCHICCI

Ed table is the perfect mix between different shape and material: its conical base is in polyethylene and its round top in in tempered glass. Its soul mate is Zoe, a sinuous and elegant chair. Both of them can give a magic touch in their luminous version.

category **table**
material **polyethylene,**
tempered glass tabletop

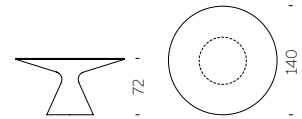

category **chair**
material **polyethylene**

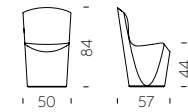

FURNITURE

YOU MAY ALSO LIKE



TAO

design GUGLIELMO BERCHICCI
category coffee table
material polyethylene,
glass tabletop

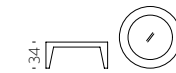

SLOTH

design KARIM RASHID
category coffee table
material polyurethane



GEAR

design ANASTASIA IVANYUK
category stool, coffee table
material polyethylene

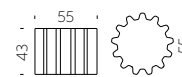

DOUBLE U

design KAZUKO OKAMOTO
category stool
material polyethylene

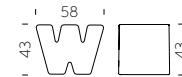

AMORE TABLE

design GIÒ COLONNA ROMANO
category coffee table
material polyethylene,
glass tabletop



TEA TIME

design GIANNI ARNAUDO
category coffee table
material polyethylene,
nr.4 wheels

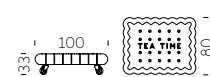

CUBO POUF

design SLIDE STUDIO
category stool, coffee table
material polyethylene



TOY

design PROSPERO RASULO
category coffee table
material polyethylene



TARTA + TARTA LOW TABLE

design ROBERTO PAOLI
category low chair + coffee table
material polyurethane,
beech legs

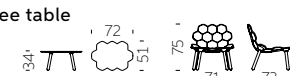

TIC TAC

design MARCO ACERBIS
category chaise-longue
material polyethylene



FURNITURE YOU MAY ALSO LIKE

FURNITURE YOU MAY ALSO LIKE

We Love
LIGHTS



BANANA LEAF



Design
MARCANTONIO



Lush, large in dimensions, with a hinting but unmistakable design: its stylised shape clearly recalls large banana leaves, under which to rest in the shade while planning, perhaps, your next holiday. It can be used individually or in endless composition possibilities. Banana Leaf is also available as a wall lamp or as a coloured, non-luminous decorative complement.

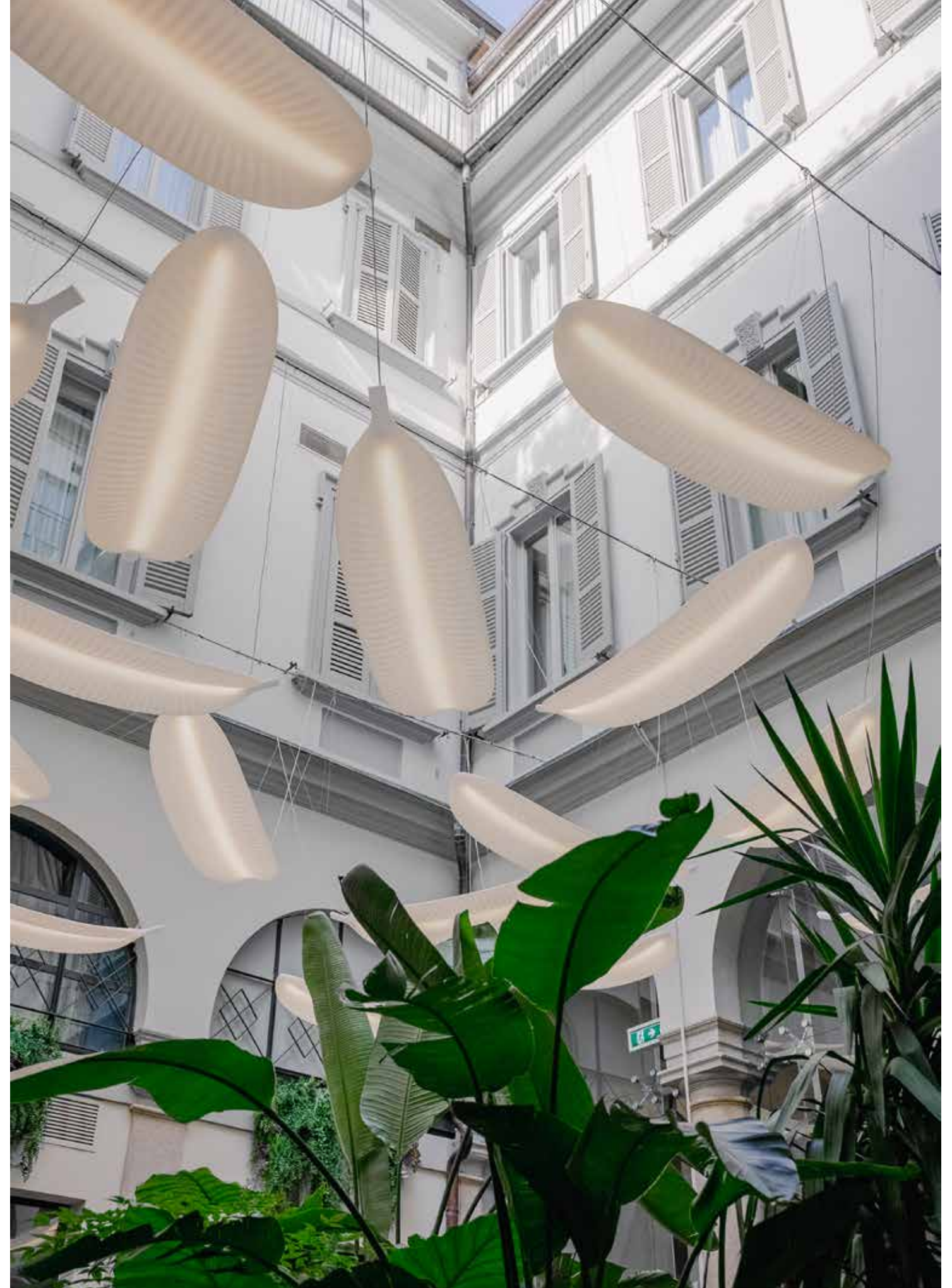



category hanging lamp, standing
 material polyethylene,
 painted metal

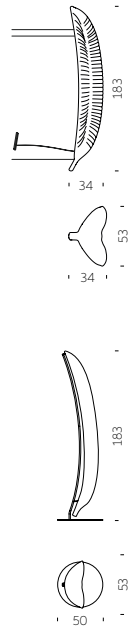

Design
ADRIANA LOHMANN

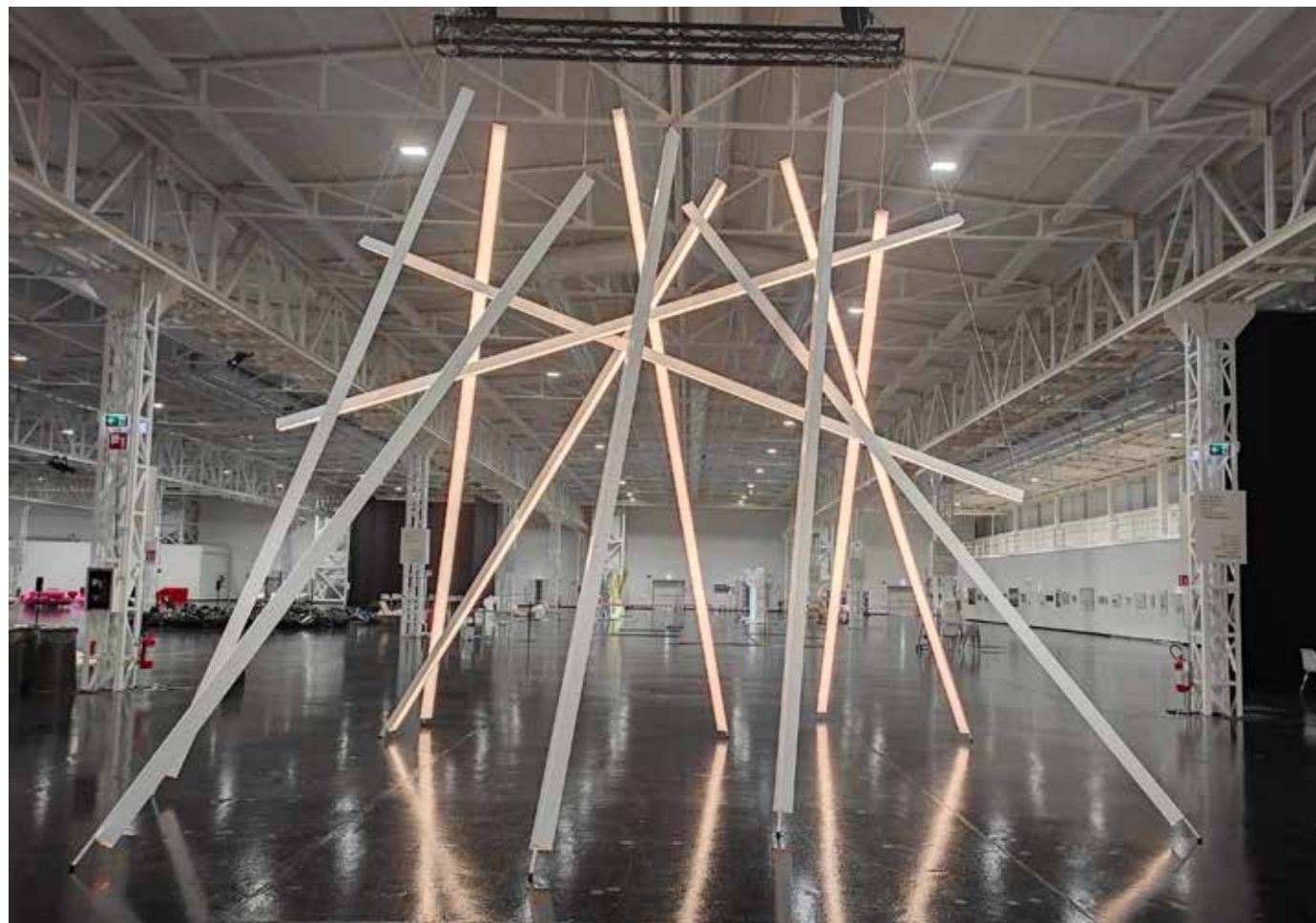

It diffuses soft, high quality light to ensure a pleasant luminous flux, direct or indirect, excellent visual comfort and natural colour brilliance. Slim is available in different lengths, ideal to be adapted in every environment, and it is available also in wall version, Slim Applique.



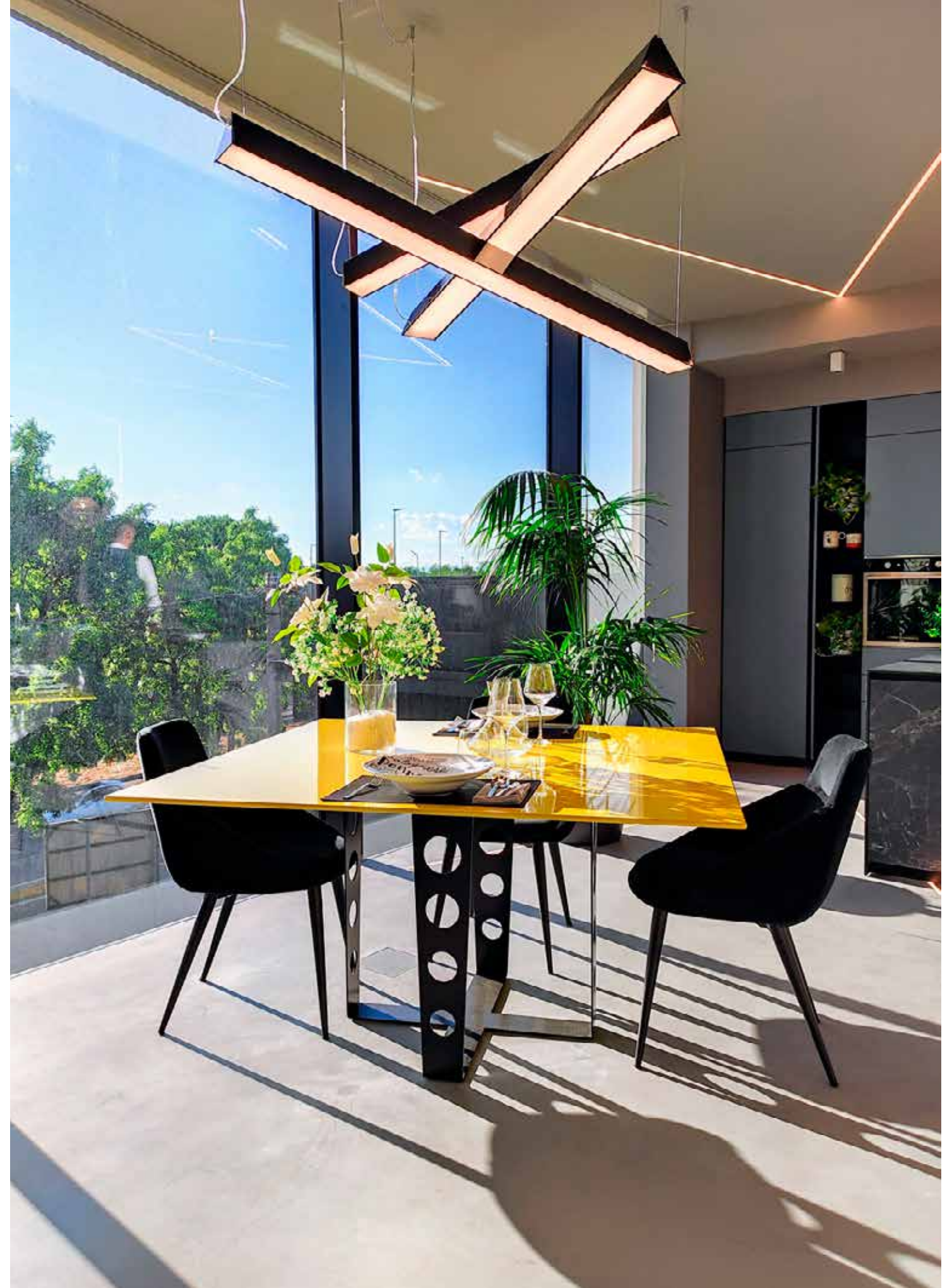
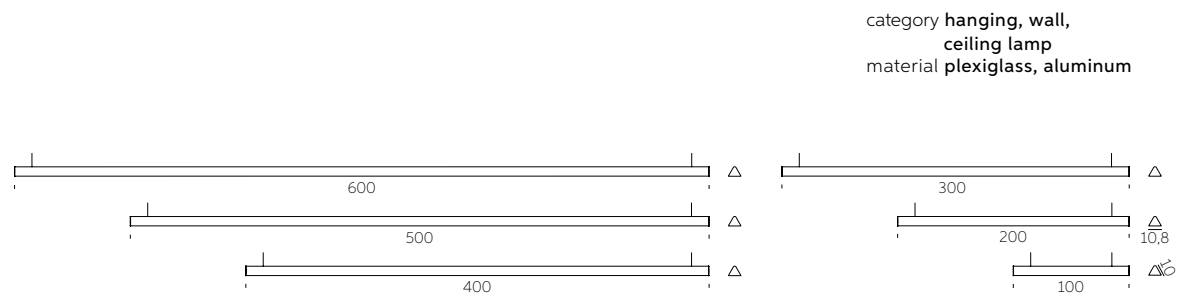

STILETTO COLLECTION



Design
ROBERTO PAOLI

Collection
STILETTO X
STILETTO Y
STILETTO APPLIQUE
STILETTO SHARD



Stiletto is a hanging lamp with an essential line, ideal for contemporary and indoor settings that require a scenographic lighting. Available in two different dimensions, both in vertical and horizontal orientation. Thanks to its minimal design, its homogeneous light and the possibility of infinite combinations.

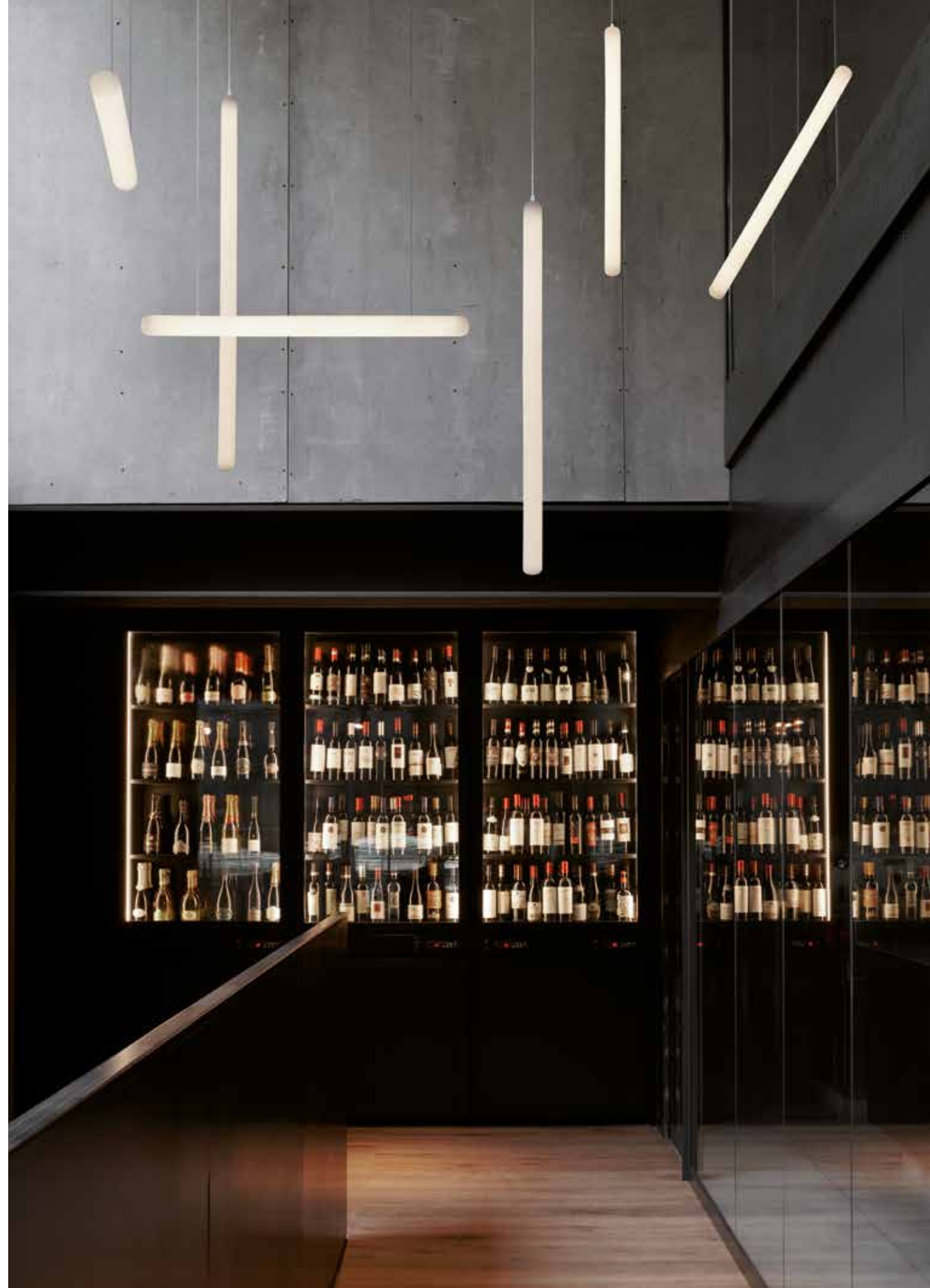



STILETTO COLLECTION

category hanging, wall, ceiling lamp
material polyethylene

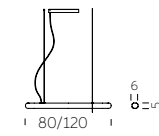

STILETTO X

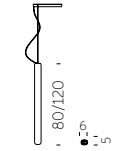

STILETTO Y

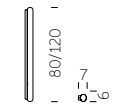

STILETTO APPLIQUE

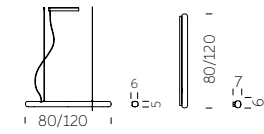

STILETTO SHARD





Design
ROBERTO PAOLI

category hanging, wall, ceiling lamp
material polyethylene

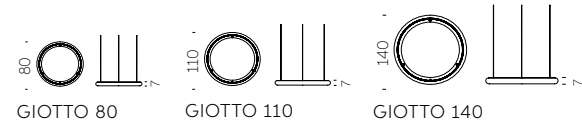

The perfect circle exists and Roberto Paoli made it in polyethylene. Giotto is a luminous hanging ring with three different LED lighting temperature, so it is perfect for every use: home, hospitality or workspace.





Giotto is a lamp with an essential geometry that can be used individually or in countless compositions. The combination of several Giotto hanging lamps can light up large areas with a strong personality. Available also as wall/ceiling lamp version.



GLOBO COLLECTION



Design
SLIDE STUDIO

Collection
GLOBO
GLOBO HANGING
GLOBO TIGE
ACQUAGLOBO



The simplicity of a luminous sphere that can create amazing and elegant atmospheres in indoor and outdoor settings. Globo collection is a numerous family: it is available in different dimensions from 25cm up to 2mt diameter, and in different version as table, floor, wall/ceiling, hanging and floating lamps.

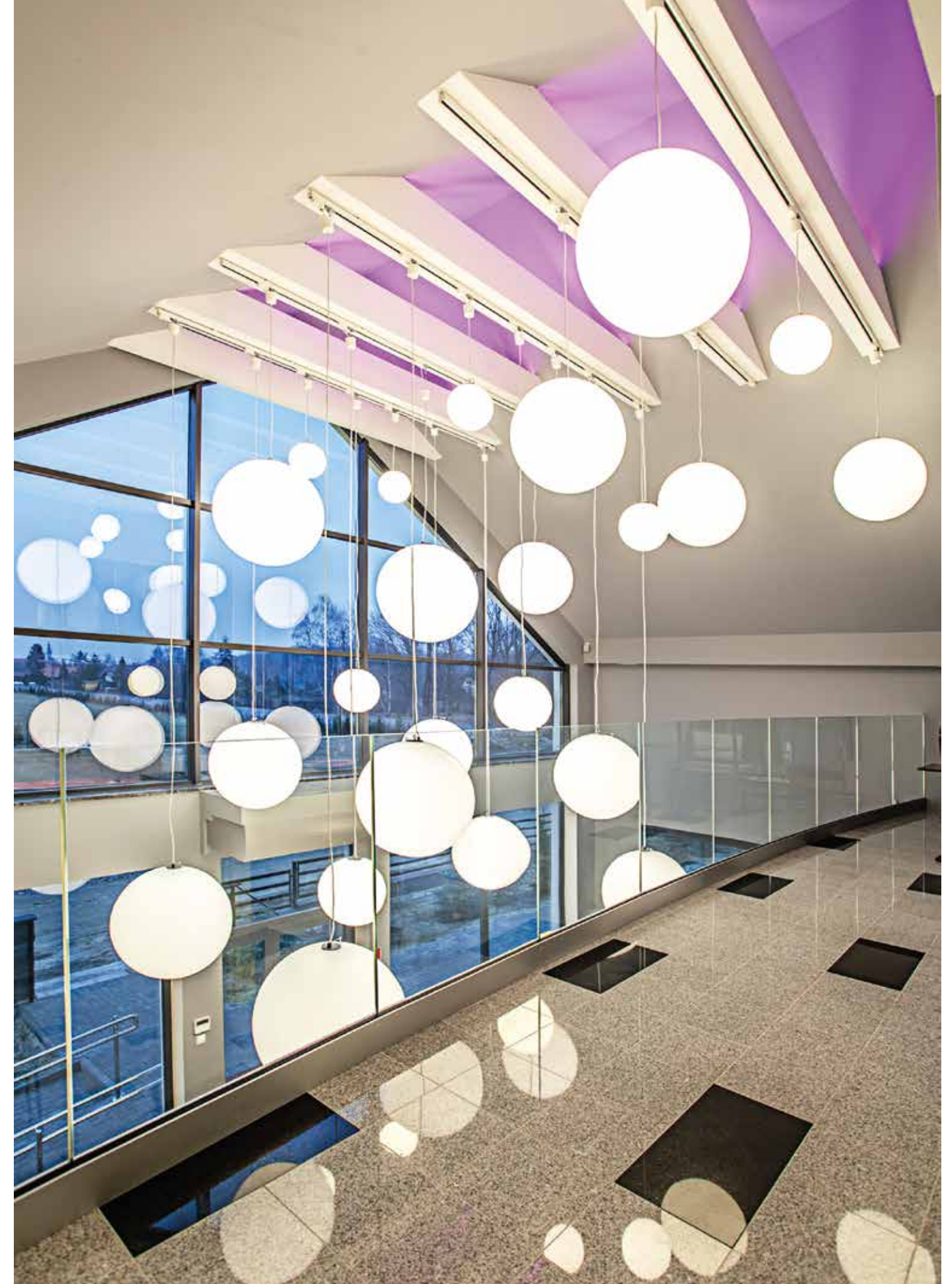



GLOBO COLLECTION

category hanging, wall, ceiling, floor lamp
material polyethylene

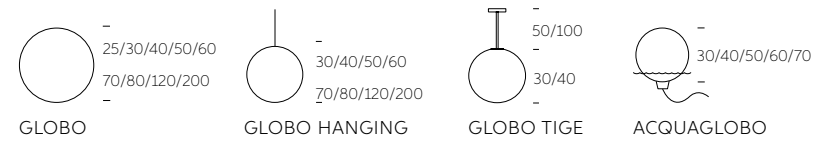

MINERAL COLLECTION



Design
SLIDE STUDIO

category table, hanging, ceiling lamp
material polyethylene



MINERAL



MINERAL HANGING



MINERAL TIGE

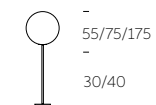

MINERAL STAND



The luxurious marble finishes, with grey and red veinings, characterize the Mineral collection. The marbled texture made the light delicate and welcoming in table, floor and hanging versions. For classy indoor spaces, simple but at the same time unforgettable.



MURANO COLLECTION



Design
SLIDE STUDIO

category table, hanging, ceiling lamp
material SAN



MURANO

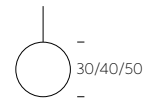

MURANO HANGING

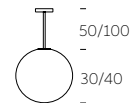

MURANO TIGE



From the ancient tradition of master glassmakers, Murano is a hanging lamp that, best of all, matches industrial series production with the wonderful imperfections of craftsmanship. With a special blend of plastic material, Murano has the iridescence of glass and each piece is unique, thanks to manual finishing. Warm light radiates uniformly thanks to the transparency of the material.

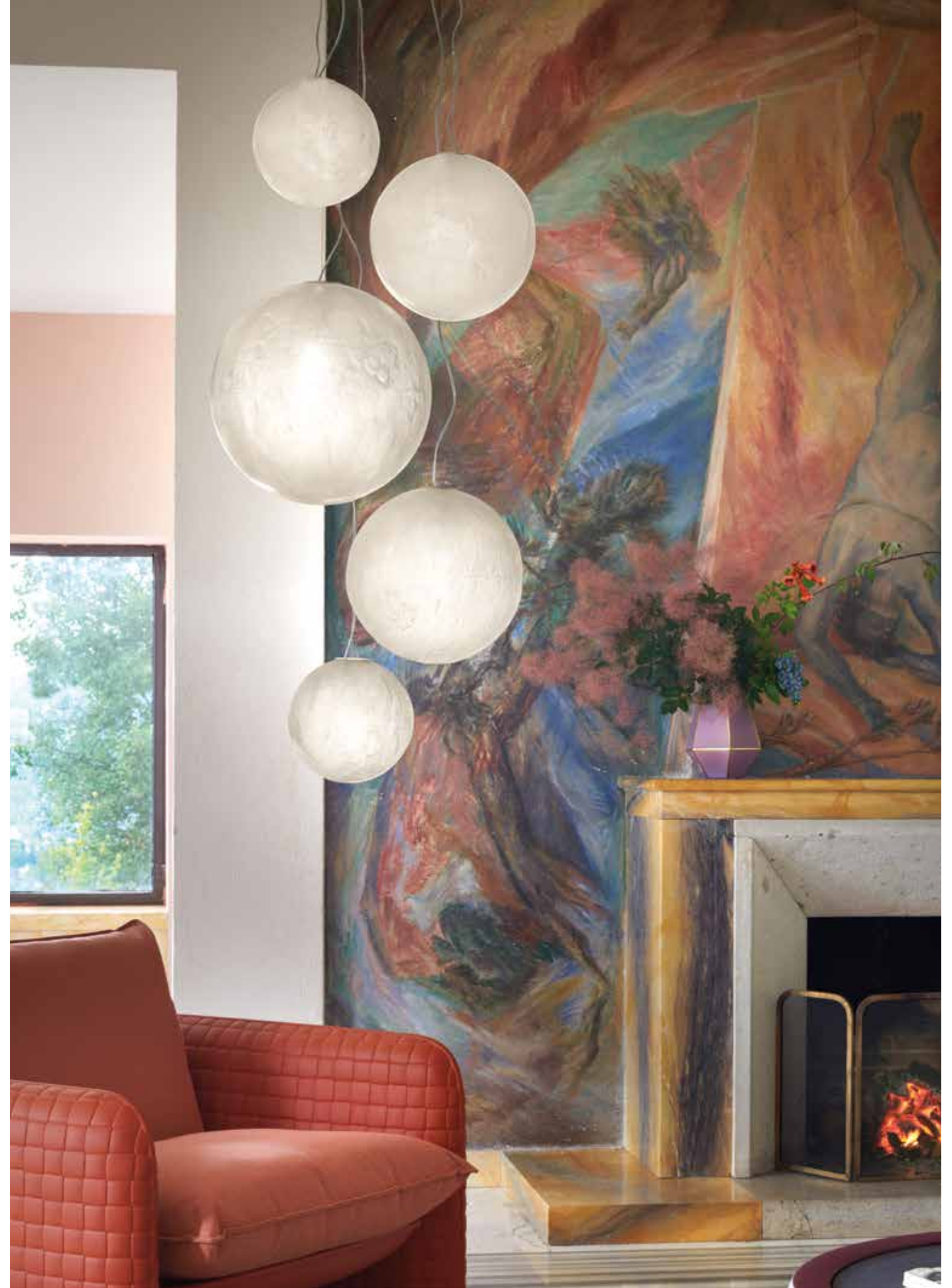

CORDIALE LUMIÈRE



Design
ROBERTO PAOLI

category hanging lamp
material polyethylene,
brass covers

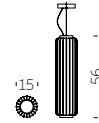

CORDIALE LUMIÈRE / ROBERTO PAOLI

WE LOVE LIGHTS

CORDIALE APPLIQUE



Design
ROBERTO PAOLI

category wall lamp
material polyethylene,
brass covers

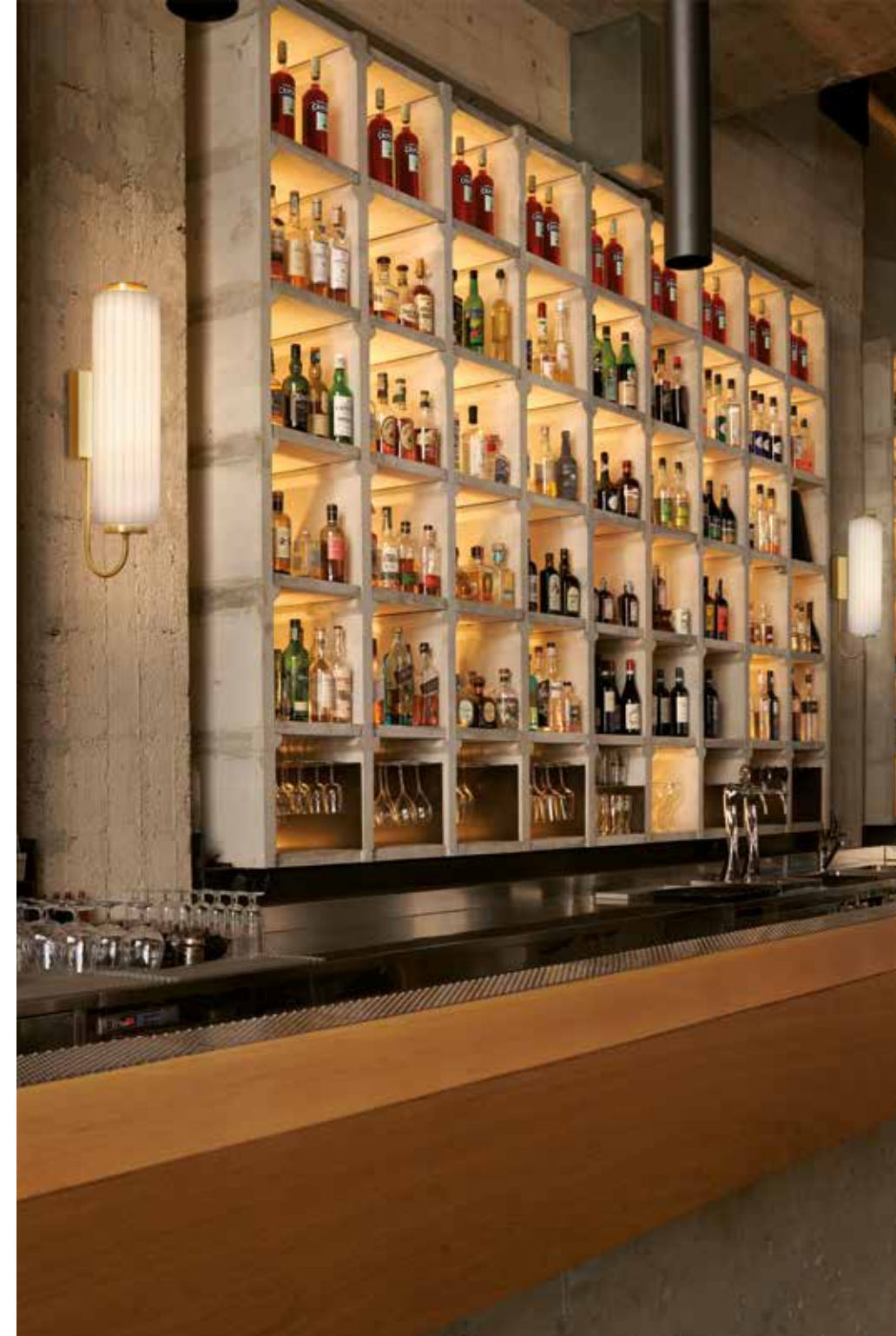
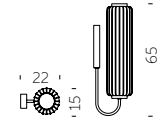

CORDIALE APPLIQUE / ROBERTO PAOLI

WE LOVE LIGHTS

BALLOON

Balloon is our newest luminous balloon with an iconic shape, available in three sizes, to create settings of great visual impact, especially by combining several Balloons together, for a sophisticated and refined scenic effect.

Design
FUORILUOGO DESIGN

category **hanging lamp**
material **polyethylene**

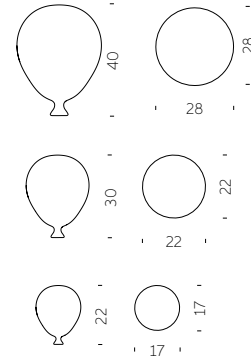

FLUX COLLECTION



Design
GIÒ COLONNA ROMANO

category floor, hanging lamp
material methacrylate

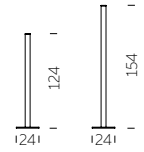

FLUX



FLUX HANGING



FLUX UP



"Silky touch, warm light and an essential design. Flux is a discreet and contemporary lamps family: their essential shape characterizes both the hanging lamp and the floor lamp. The methacrylate creates a silky-effect texture that covers the whole surface".



Design
FABIO NOVEMBRE

category hanging, wall,
ceiling lamp
material polyethylene

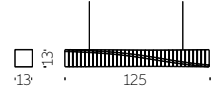

SPIN HANGING

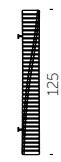

SPIN WALL CIELING



“Sometimes a spin is needed to make a pure shape vibrate. Spin hanging/wall lamp comes from the twist of a square-based parallelepiped element. The modularity allows obtaining long and sinuous elements that can vary, in terms of composition, based on the aggregation method”.

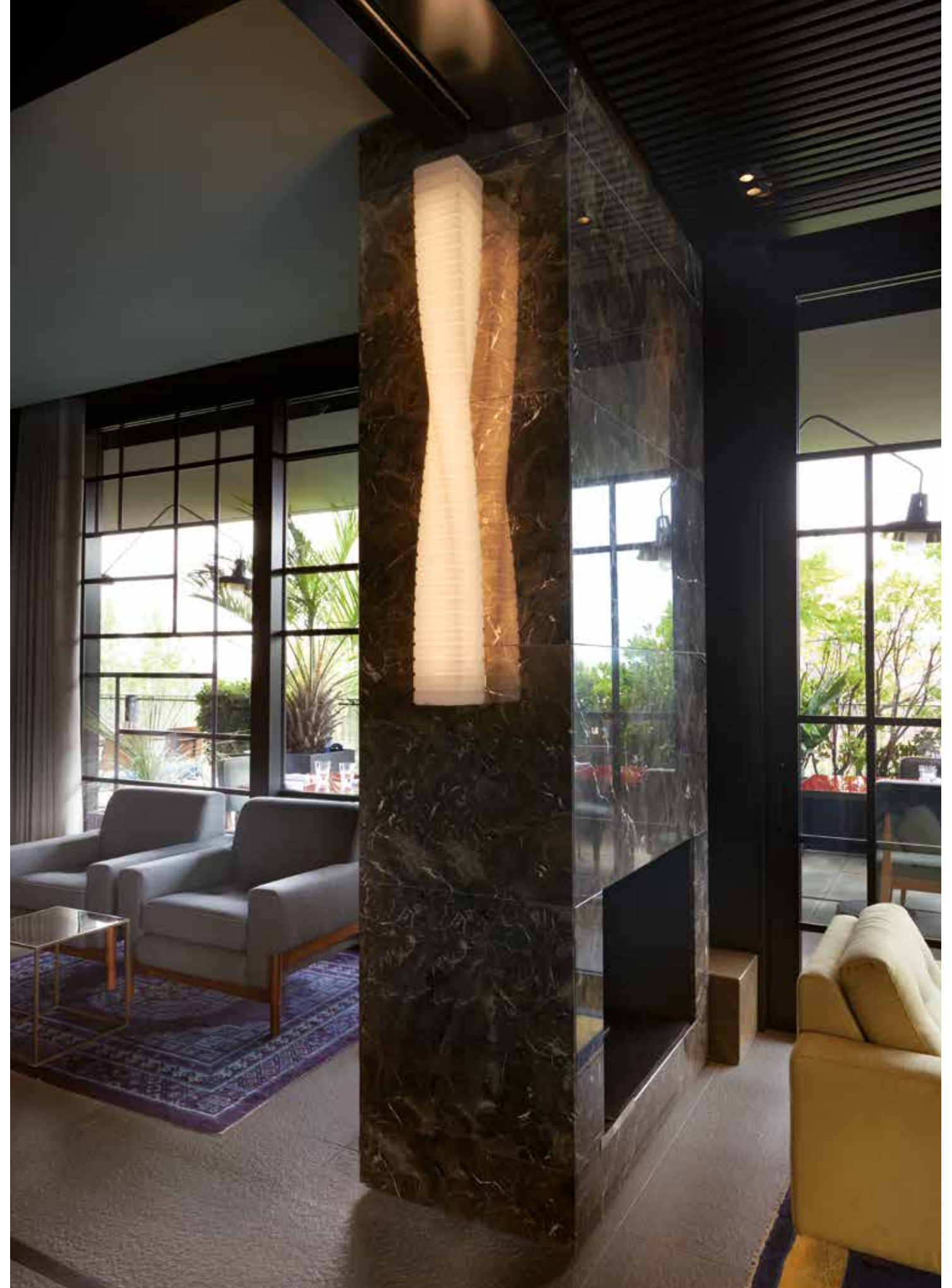

PLUME

PLUME / GIÒ COLONNA ROMANO

Design
GIÒ COLONNA ROMANO

category **hanging lamp**
material **fiberglass**

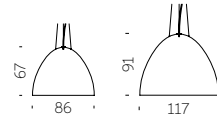

ELIOS

ELIOS / GIÒ COLONNA ROMANO

Design
GIÒ COLONNA ROMANO

category **hanging lamp**
material **fiberglass**

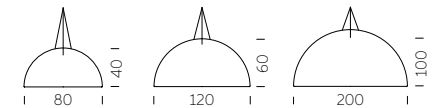

"Light, essential and thin: Elios and Plume were born from the continuous research of material: the fiberglass process creates a family of hanging lamps that becomes richer thanks to the contrast between the external side of the lamp, in different colours, and the brightness of the inner side".

Giò Colonna Romano



CUPOLE

Cupole hanging lamp has got an ordinary shape but extraordinary dimensions. Its half-sphere shape is suitable for every indoor settings: Cupole can give a touch of strong personality to every anonymous area. Available in three different dimensions, it gives a playful touch in standard colours, or to be elegant and sophisticated in the two-coloured lacquered version.

Design
GIÒ COLONNA ROMANO

category **hanging lamp**
material **polyethylene**

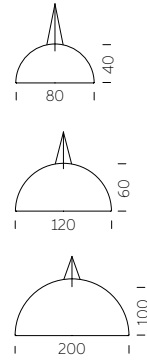

DAME OF LOVE



Design
MORO & PIGATTI

category hanging lamp
material polyethylene



DAME OF LOVE / MORO & PIGATTI

WE LOVE LIGHTS

CROWN OF LOVE



Design
MORO & PIGATTI

category hanging lamp
material polyethylene

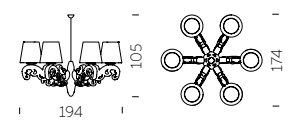

CROWN OF LOVE / MORO & PIGATTI

WE LOVE LIGHTS

CORDIALINA

Design
ROBERTO PAOLI

category **table lamp**
material **polyethylene, brass**

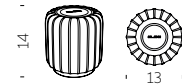

Cordialina is the table lamp with rechargeable battery which recalls the Art Deco style that inspired the whole Cordiale collection, composed by bar counters and lamps. The elegant design, embellished with brass elements, and the homogeneous light make Cordialina ideal to create a discreet and welcoming table centrepiece. Logo can be personalized on request

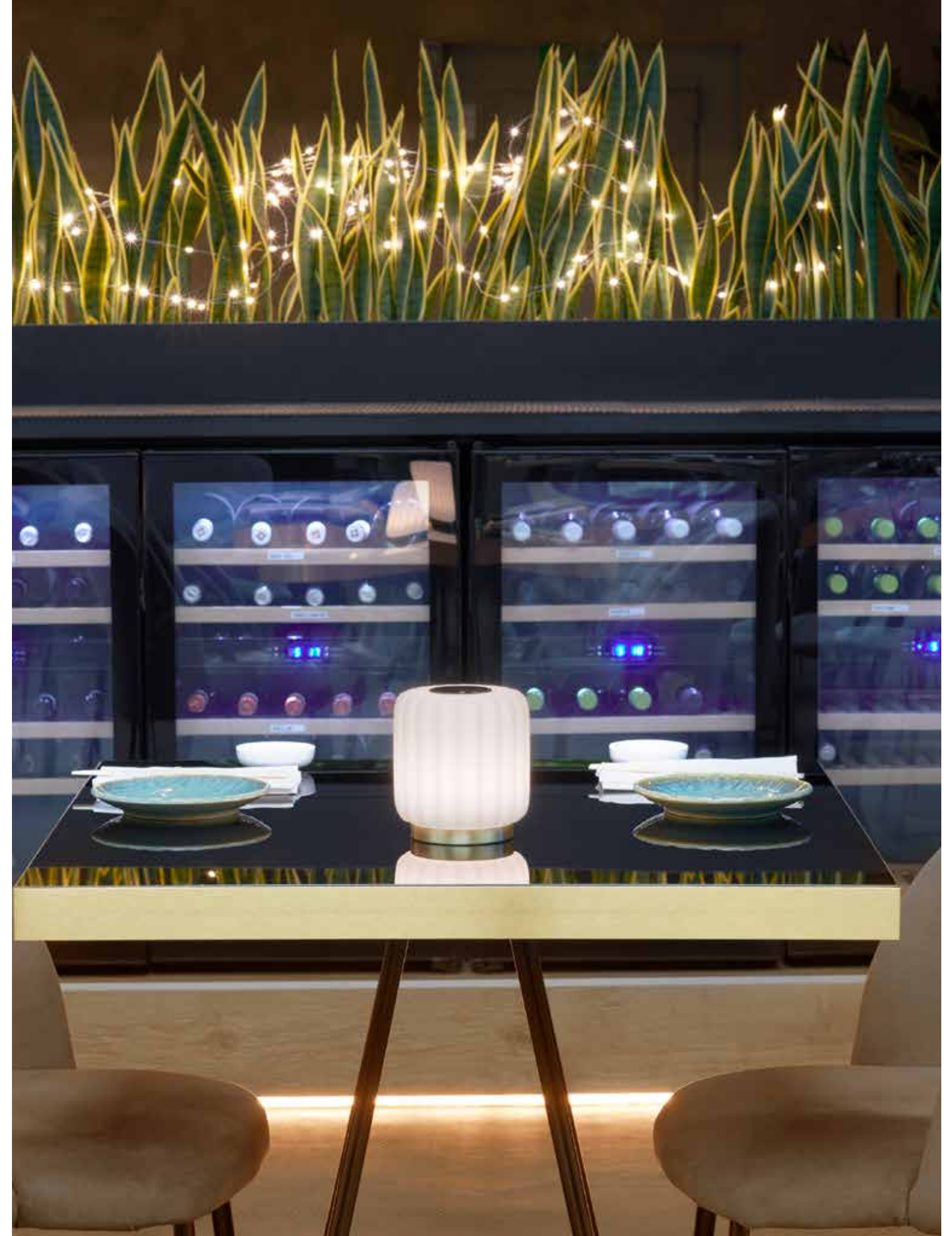

Design
ANTONIO LANZILLO & PARTNERS

category **table lamp**
material **plexiglass**
metal base

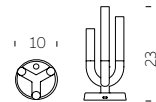

"Luna is a romantic light, full of emotion, that evokes classic scenarios. A warm, poetic lamp with a technological heart: rechargeable, dimmable, soft touch."



OTTOCENTO LAMP



Design
PAOLA NAVONE - OTTO STUDIO

category floor lamp
material polyethylene

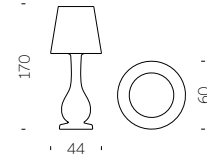

With its refined base inspired by Neoclassicism artistic movement and its rich-in-Arabesque-details lampshade, Ottocento Lamp is the new item of Ottocento collection created by Paola Navone. The ten-year collaboration with the designer led to the birth of the first floor lamp designed for SLIDE, ideal for lighting up indoor and outdoor spaces.



Design
LORENZA BOZZOLI

category **floor lamp**
material **polyethylene**

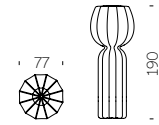

Good Design
Award 2018

Inspired by the simple shapes of flowers, vegetables and bulbs, Cucun floor lamp merges perfectly with the Nature around it. Thanks to its strong decorative presence, it is ideal to furnish both domestic and commercial areas, both for indoor and outdoor spaces.

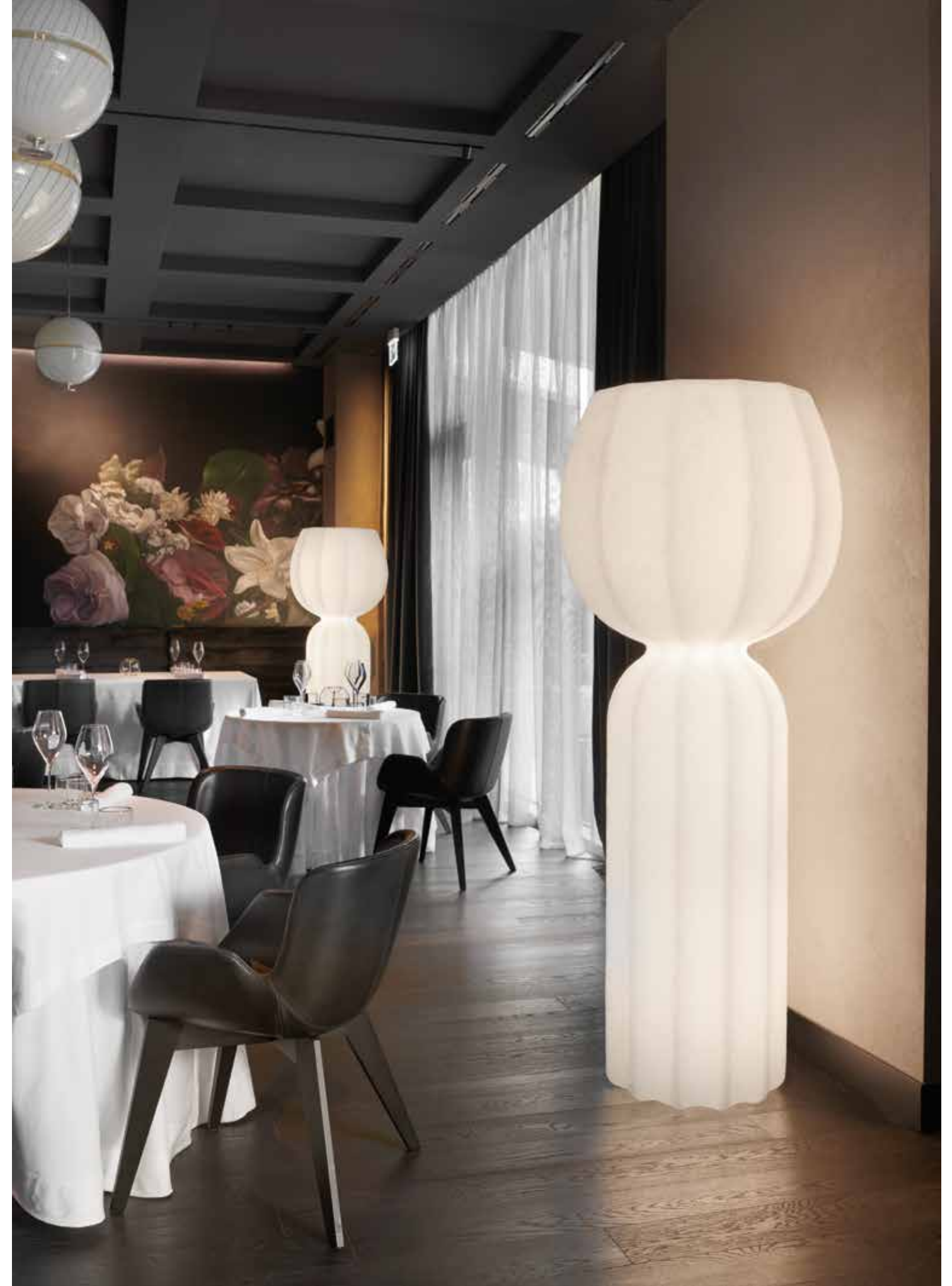



Design
LORENZA BOZZOLI

category **table lamp**
material **polyethylene**

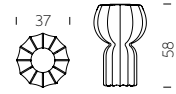

A sheet of ancient Japanese paper inspiration, which covers the whole surface, creates soft light effects. The particular structure, with its ribs, is a tribute to some icons of Italian design of the last century. Pupa table lamp is perfect for warm and refined atmospheres and contemporary indoor settings.

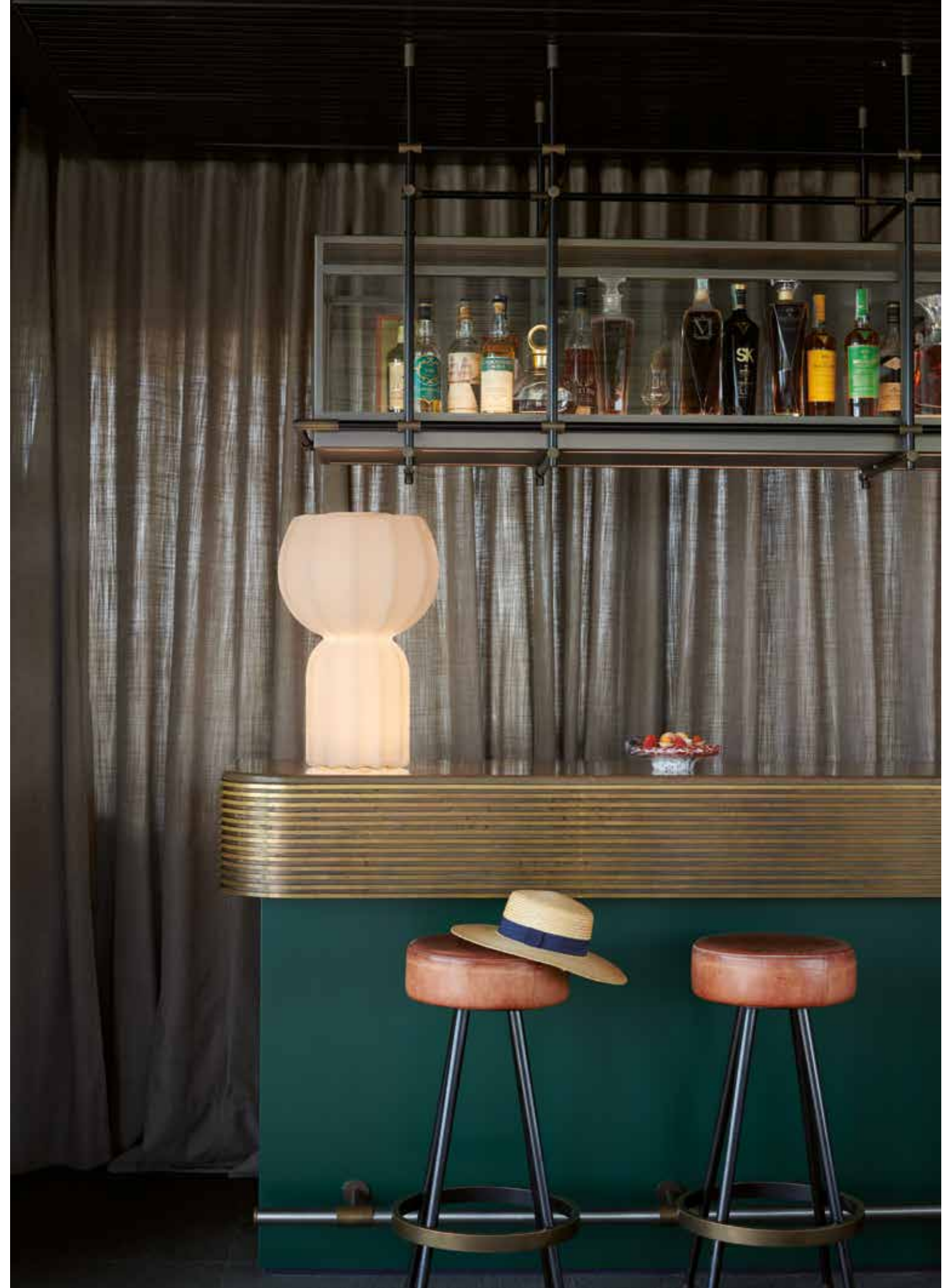

Design
SLIDE STUDIO

category floor lamp
material polyethylene

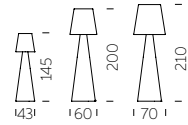

The linear design of Pivot collection is the result of the perfect mix between the conical shape of the base and the classic shape of the lampshade. The main characteristic of Pivot is the texture on its lampshade, which reminds of the classical arabesque motif: available in three different dimensions.



ALI BABA STEEL



Design
SLIDE STUDIO

category floor lamp
material polyethylene,
galvanized metal base

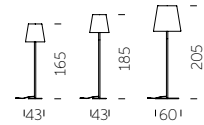

ALI BABA STEEL / SLIDE STUDIO

WE LOVE LIGHTS

FIACCOLA ALI BABA



Design
SLIDE STUDIO

category floor lamp
material polyethylene,
galvanized metal base

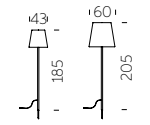

FIACCOLA ALI BABA / SLIDE STUDIO

WE LOVE LIGHTS

ALI BABA WOOD



Design
SLIDE STUDIO

category floor lamp
material polyethylene,
wood beech base

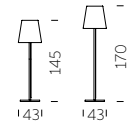

ALI BABA WOOD / SLIDE STUDIO

WE LOVE LIGHTS

GLOBO WOOD



Design
SLIDE STUDIO

category floor lamp
material polyethylene,
wood beech base

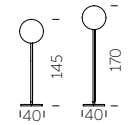

GLOBO WOOD / SLIDE STUDIO

WE LOVE LIGHTS

KING OF LOVE



Design
MORO & PIGATTI

category floor lamp
material polyethylene

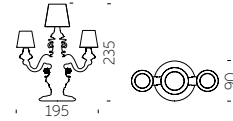

MADAME OF LOVE



Design
MORO & PIGATTI

category floor lamp
material polyethylene

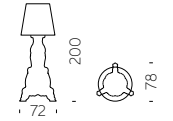

An Italian baroque classic, the abat-jour, is reinterpreted in pop and ironic style: Madame of Love is a floor lamp that reminds the same shape of the abat-jour, but it is bigger than the classic lamp and it has got a contemporary base made in polyethylene.



Design
SLIDE STUDIO

category **floor lamp**
material **polyethylene**

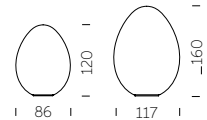

Design
SLIDE STUDIO

category **table, floor, hanging lamp**
material **polyethylene**

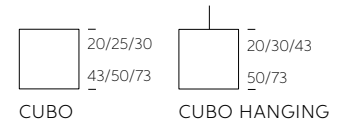

The sweet and sensual light of Cubo collection is able to create a lounge and elegant setting in every indoor and outdoor contract project, so Cubo becomes one of the Slide bestsellers.



LIGHTS

YOU MAY ALSO LIKE



OTELLO

design GIÒ COLONNA ROMANO
category table lamp
material aluminium



HERE

design ALESSANDRO MENDINI
category table lamp
material polyethylene

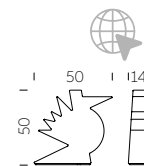

CARMEN

design GIÒ COLONNA ROMANO
category table lamp
material aluminium



KOKÒ

design GIÒ COLONNA ROMANO
category table lamp
material polyethylene



PRÊT-À-PORTER

design ANTONIO NORERO
category table lamp
material polyethylene



KRISTALINA

design ADRIANA LOHMANN
category table lamp
material polyethylene

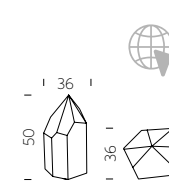

FIAMMETTA + FIAMMA

design ALBERTO GIRARDELLO
category table lamp
material polyethylene

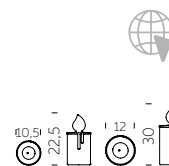

PURE

design LAB81
category table lamp
material polyethylene



LOVE

design STEFANO GIOVANNONI
category table lamp
material polyethylene,
metal base

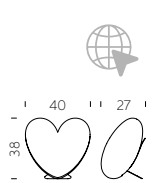

KOLME + KUUSI

design ROBERTO PAOLI
category table, floor lamp
material polyethylene





THERE

design **ALESSANDRO MENDINI**
category **floor lamp**
material **polyethylene**

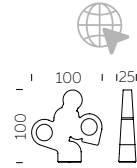

BIJOUX

design **BÜRO FÜR FORM**
category **floor, hanging lamp**
material **polyethylene**

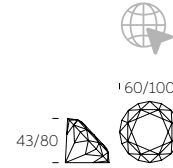

GLOBO WALL

design **SLIDE STUDIO**
category **wall, ceiling lamp**
material **polyethylene**



MOLLY

design **SLIDE STUDIO**
category **hanging lamp**
material **polyethylene**

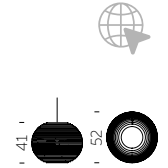

LIGHTTREE

design **LOETIZIA CENSI**
category **table, floor lamp**
material **polyethylene**



MANHATTAN

design **GIÒ COLONNA ROMANO**
category **floor lamp**
material **polyethylene**



JUXT

design **KARIM RASHID**
category **hanging lamp**
material **polyethylene**

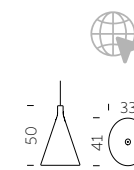

SUNDAY

design **SLIDE STUDIO**
category **hanging lamp**
material **polyethylene**

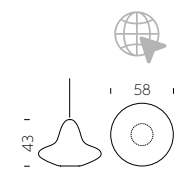

FLUO

design **SLIDE STUDIO**
category **floor lamp**
material **polyethylene**

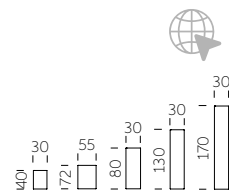

CONO

design **SLIDE STUDIO**
category **floor lamp**
material **polyethylene**

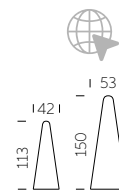

ICO

design **STUDIOPANG**
category **hanging lamp**
material **polyethylene**

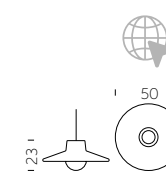

MESH

design **BBMDS**
category **hanging lamp**
material **polyethylene**

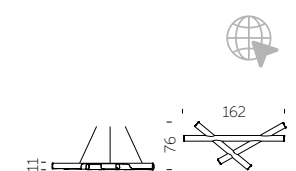

We Love
HOSPITALITY



CORDIALE COLLECTION



Design
ROBERTO PAOLI

Collection
CORDIALE
CORDIALE CORNER
CORDIALE WELCOME



"The function becomes the first step for the creation of the shape in the Cordiale bar counter. Cordiale can give a sweetly retro style to a contemporary space. The geometries that make up the project, as well as the surface finishes, lead back to materials such as stone or hand-made wood essences".







CORDIALE COLLECTION

category **bar counter**
material **polyethylene**

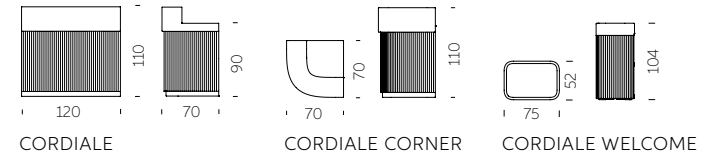

BREAK COLLECTION



Design
SLIDE STUDIO

Collection
BREAK BAR
BREAK LINE
BREAK CORNER
ICE BAR



The magic of the light and the simplicity of polyethylene: the Break collection is the perfect combination for events, restaurants and lounge bars. The luminous bar counters light up big areas and create magical and unforgettable moments for all the guests.

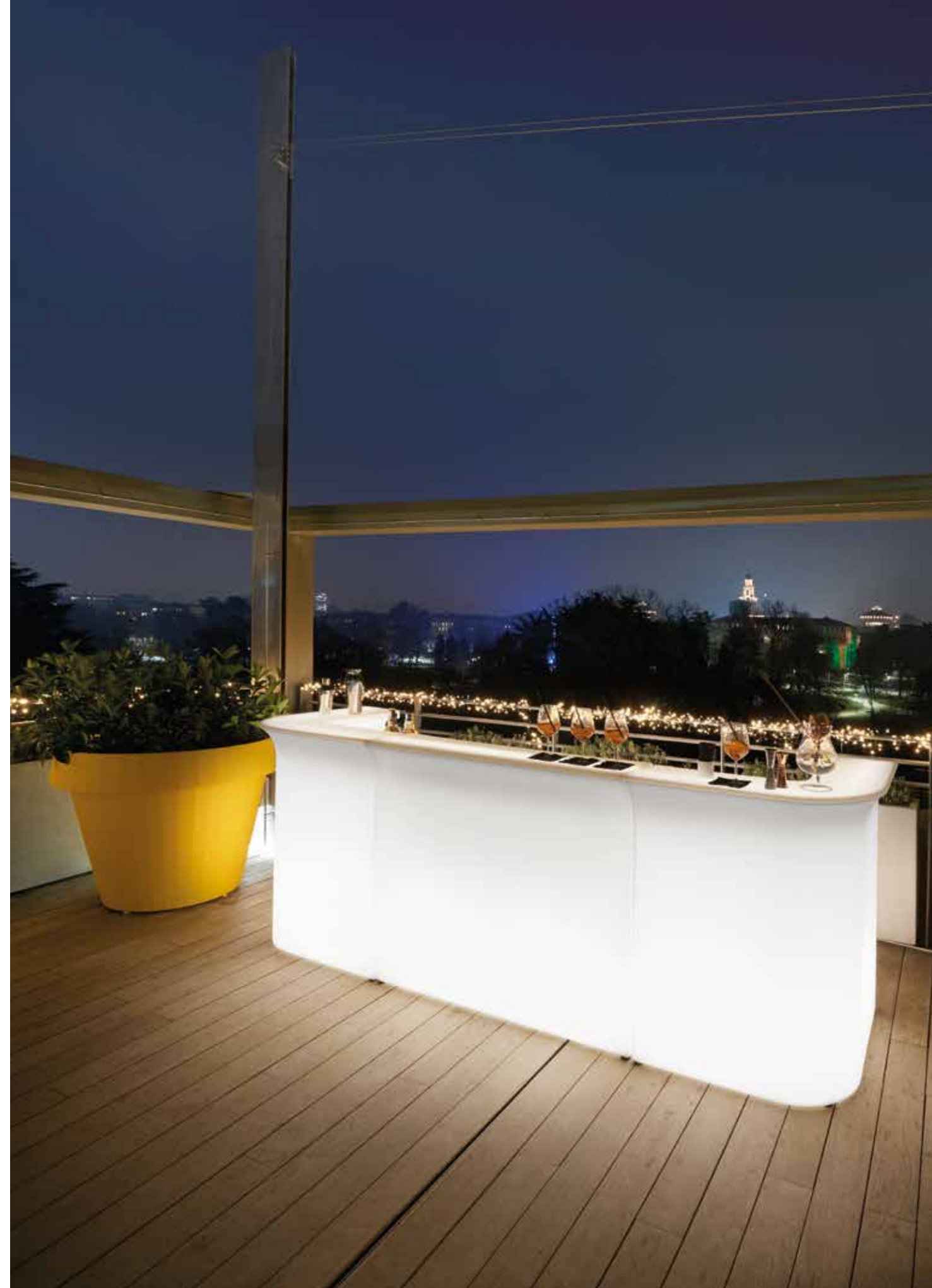



BREAK COLLECTION

category **bar counter**
material **polyethylene**

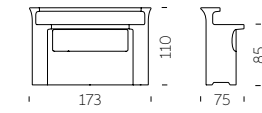

BREAK BAR

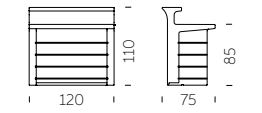

BREAK LINE

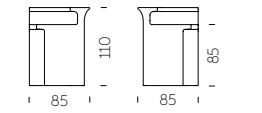

BREAK CORNER

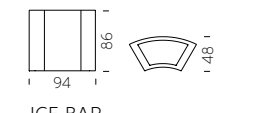

ICE BAR



SNACK BAR



Design
SLIDE STUDIO

category **bar counter**
material **polyethylene**

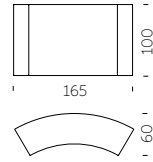

SNACK BAR / SLIDE STUDIO

WE LOVE HOSPITALITY

JUMBO COLLECTION



Design
JORGE NAJERA

category **bar counter**
material **polyethylene**

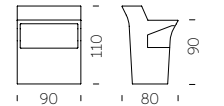

JUMBO BAR

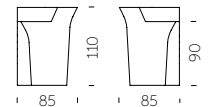

JUMBO CORNER

The first real success of Slide, Jumbo Bar is the ancestor of the whole production of luminous bar counters. Jumbo Bar and Jumbo Corner are suitable to create unique events, both in indoor and outdoor spaces.



JUMBO COLLECTION / JORGE NAJERA

WE LOVE HOSPITALITY

SWISH

SWISH / KARIM RASHID



Design
KARIM RASHID

category lectern
material polyethylene

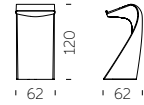

ROLLER BAR

Design
GERD VAN CAUTEREN

category bar counter with wheels
material polyethylene

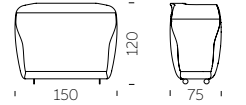

ROLLER BAR / GERD VAN CAUTEREN

Design
KARIM RASHID

category bar counter
material polyethylene,
glass top

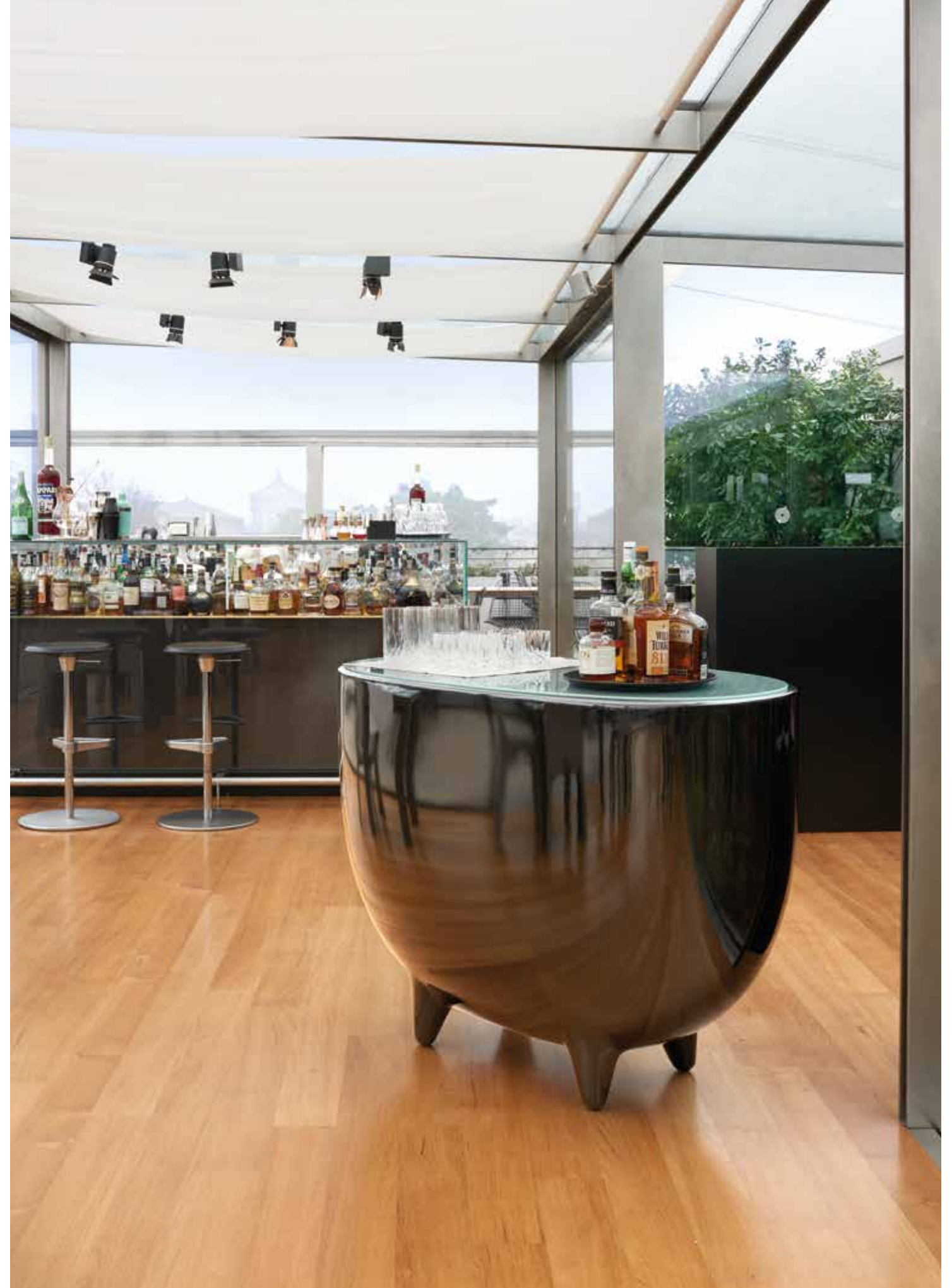
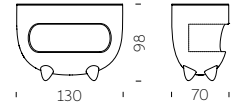

GIÒ POUF



Design
SLIDE STUDIO

category pouf
material polyethylene,
ecoleather cushion

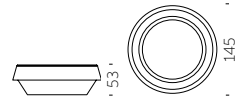

SNAKE



Design
SLIDE STUDIO

category modular seat
material polyethylene

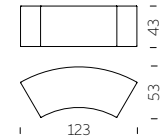

The perfect match between aesthetic and functionality: Snake designs and organizes the spaces with elegance and essentiality. Luminous and modular, Snake creates dreamy atmosphere during special events or in contemporary contract projects.



SOFT SNAKE



Design
SLIDE STUDIO

Soft Snake and Soft Cubo are an even more comfortable reinterpretation of Slide bestsellers Snake and Cubo. Made in soft polyurethane, they can perfectly match with their luminous version in polyethylene, in both indoor and outdoor settings.

category **soft modular seat**
material **soft polyurethane**

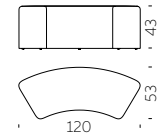

SOFT CUBO



Design
SLIDE STUDIO

category **soft stool**
material **soft polyurethane**

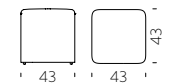

PINT



Design
SLIDE STUDIO

Pint is an extremely elegant and linear luminous high table. The conical shape of Pint matches perfectly with the round tempered glass top, which gives a more sophisticated look to events and contract.

category **table**
material **polyethylene,**
tempered glass tabletop

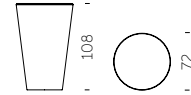

PINT / SLIDE STUDIO



SQUARE



Design
SLIDE STUDIO

category **table**
material **polyethylene,**
tempered glass tabletop

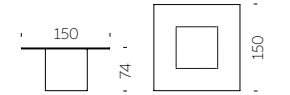

SQUARE / SLIDE STUDIO



GLORIA

Design
MARC SADLER

category chair
material polypropylene,
steel chassis

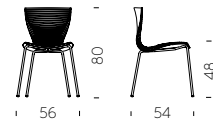

GLORIA / MARC SADLER

WE LOVE HOSPITALITY

GLORIA MEETING

Design
MARC SADLER

category chair
material polypropylene,
steel chassis



GLORIA MEETING / MARC SADLER

WE LOVE HOSPITALITY



Design
GIANNI ARNAUDO

category table
material polyethylene

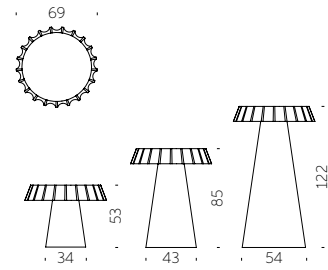

Design
SLIDE STUDIO

category stool
material polyethylene

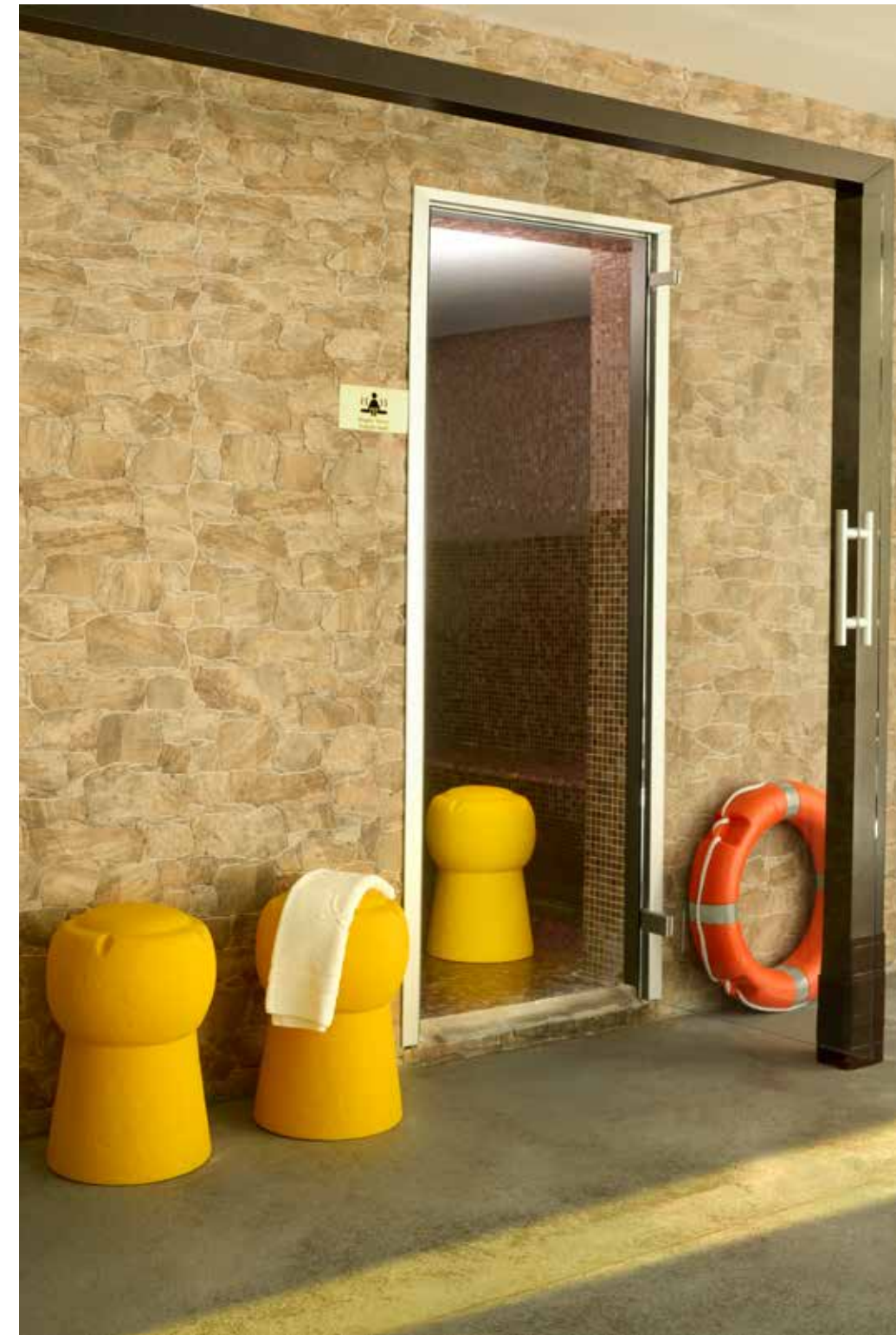
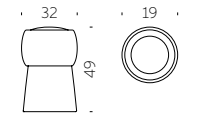



Design
MARC SADLER

category **table**
material **polyethylene,**
hpl tabletop

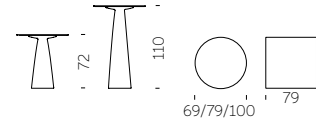

Informal and refined at the same time, Hoplà is a family of stylish tables designed by Marc Sadler. Everyone can create their own perfect Hoplà table: you can choose from various heights and different shapes of HPL tops.



DRINK



DRINK / JORGE NAJERA

Design
JORGE NAJERA

category **high stool**
material **polyethylene**

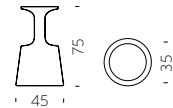

PEAK



Design
AKSU & SUARDI STUDIO

category **table**
material **polyethylene,**
tempered glass tabletop

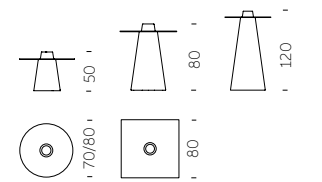

The main reason for the success of Peak is its eccentric design: the simple and conical base shape ends with a hole that can become a bottle rack or a romantic flowerpot. The fancy base of Peak is available in different heights.



PEAK / AKSU & SUARDI STUDIO

KONCORD + JET



Design
KARIM RASHID

category **high stool**
material **polyethylene**

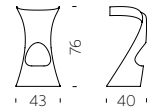

category **table**
material **polyethylene**

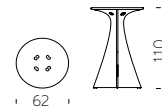

"I love plastic. I always have and always will. Plastic has afforded a warm, soft, malleable, flexible, comfortable, lightweight democratic landscape reaped with innovation. And with that I made Koncord, an entirely unique shape that is only made possible by plastic. The resulting form of movement speaks about our dynamic digital age."

Karim Rashid



AMÉLIE COLLECTION



Design
ITALO PERTICHINI

Collection
AMÉLIE
AMÉLIE DUETTO
AMÉLIE PANCHETTA
AMÉLIE SGABELLO
AMÉLIE SIT UP
AMÉLIE UP

AMÉLIE COLLECTION

category chair, sofa, bench, stool,
high stool, table
material polyethylene



AMÉLIE



AMÉLIE DUETTO

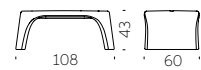

AMÉLIE PANCHETTA

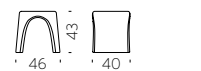

AMÉLIE SGABELLO

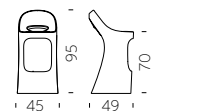

AMÉLIE SIT UP

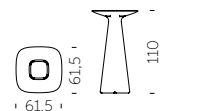

AMÉLIE UP



“The project idea derives from the careful observation of what is around us. Modify the existing in order to adapt it to new needs. The conical shape means stability and stackability par excellence. The unnecessary was removed, so Amélie was born: solid, stable, stackable.”





Design
JORGE NAJERA

category chair
material polyethylene

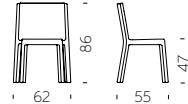

Design
GIÒ COLONNA ROMANO

category table
material polyethylene,
tempered glass tabletop

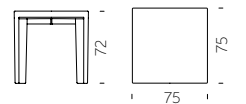

MISTER OF LOVE



Design
MORO & PIGATTI

category high stool
material polyethylene

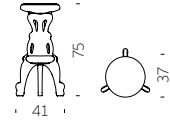

MISTER OF LOVE / MORO & PIGATTI

WE LOVE HOSPITALITY

MASTER OF LOVE



Design
MORO & PIGATTI

category table
material polyethylene,
hpl tabletop

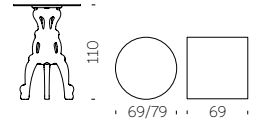

MASTER OF LOVE / MORO & PIGATTI

WE LOVE HOSPITALITY

PRINCESS OF LOVE



Design
MORO & PIGATTI

category chair
material polyethylene

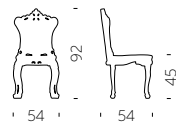

PRINCESS OF LOVE / MORO & PIGATTI

WE LOVE HOSPITALITY

LORD OF LOVE



Design
MORO & PIGATTI

category table
material polyethylene,
hpl tabletop

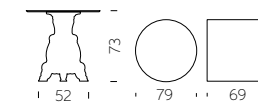

LORD OF LOVE / MORO & PIGATTI

WE LOVE HOSPITALITY

SIR OF LOVE



Design
MORO & PIGATTI

category table
material polyethylene,
glass, hpl tabletop



With its royal and majestic presence, Sir of Love table turns every evening into a real black-tie event. Its four arched legs are rich in details, as the typical Italian baroque style, but it is made in polyethylene, a contemporary and pop material.



HOSPITALITY YOU MAY ALSO LIKE



EXOFA

design **JORGE NAJERA**
category **armchair**
material **polyethylene**

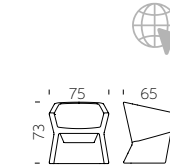

DOUBLIX

design **STIRUM DESIGN**
category **chair**
material **polyethylene**

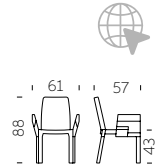

SUMMERTIME

design **GIÒ COLONNA ROMANO**
category **pouf**
material **polyethylene**

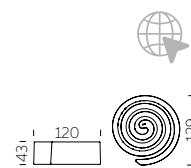

BOT ONE

design **FABIO DELLA FIORENTINA**
category **pouf**
material **polyethylene**

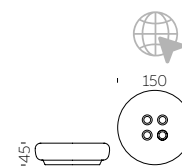

LAZY BONES

design **BARNABY GUNNING**
category **high stool**
material **polyethylene**

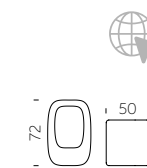

ATLAS

design **GIORGIO BISCARO**
category **bench**
material **polyethylene**

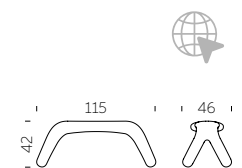

MOON

design **ALAIN HADIFE**
category **pouf**
material **polyethylene**

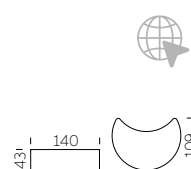

YPSILON

design **SLIDE STUDIO**
category **modular seat**
material **polyethylene**



ALIBABA STOOL

design **GIÒ COLONNA ROMANO**
category **Stool**
material **polyethylene, galvanized metal base**

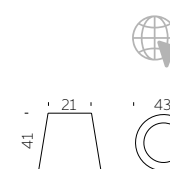

X2

design **SLIDE STUDIO**
category **table**
material **polyethylene**

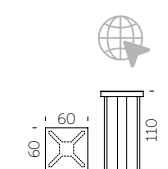

We Love
COMPLEMENTS



AMORE OCEAN



Design
GIÒ COLONNA ROMANO

category bench
material recycle plastic from
fishing nets and
marine ropes



watch the video!



To celebrate the 10th anniversary of the Amore bench, Amore Ocean is born as a special edition made with recycled materials derived from fishing nets and marine ropes. Available in two exclusive colours, Atlantic Blue and Pacific Green, Amore Ocean combines elegance, innovation, and a strong commitment to sustainability, carrying with it a message of respect for the sea and the environment.

AMORE

Design
GIÒ COLONNA ROMANO

category bench
material polyethylene



"Amore bench represents the synthesis of the main characteristics of SLIDE production. Love ("amore" in Italian) for the colour, love for the original design, love for the unusual shapes. This bench is a sculpture and a positive hymn to love, which should be present in all its shapes inside every home".



ENJOY

Design
ADRIANA LOHMANN,
GIÒ COLONNA ROMANO

category bench
material polyethylene



Sinuous, ergonomic and symmetrical, a functional sculpture symbol of happiness: Enjoy is the bench designed by Adriana Lohmann and Giò Colonna Romano, conceived and produced with two seats, because joy must be shared! Enjoy is versatile, ready to bring its wish for the joy of living into indoor and outdoor settings, and transversal: the word in fact reads identically on both sides.



Design
KAZUKO OKAMOTO

category **bench**
material **polyethylene**



The calligraphic and palindromic WOW creates amazement and happiness in every kind of settings. This pop seat pays a tribute to the comics culture in Japan, where Kazuko Okamoto was born.



AMBROGIO

Design
FAVARETTO&PARTNERS

category **servant table**
material **polyethylene,**
wood removable tray

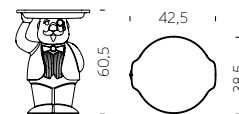

"Ambrogio and Amanda, with a wink to green side, are nice and attractive items, but at the same time they are eco-friendly. Thanks to Ambrogio and Amanda, Design becomes democratic, ethic and ideal to improve our planet."



AMANDA

Design
FAVARETTO&PARTNERS

category **servant table**
material **polyethylene,**
wood removable tray

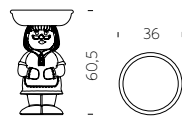

TOGETHER

Design
FAVARETTO&PARTNERS

category **servant table**
material **polyethylene, ecoAllene**

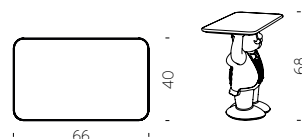

Amanda and Ambrogio have never been so close! Favaretto&Partners creates the new servant table Together, which gets born from the union of the figures of Amanda and Ambrogio. Together is a double-face table that recalls Amanda's shapes on one side and Ambrogio's on the other, and is ideal to be placed next to a sofa or used as an emptying shelf, for a pop touch in a residential project, or at a restaurant table, as a base or side table.



BUNNY COSMO BUNNY

Design
AKI KURODA

category complement
material polyethylene

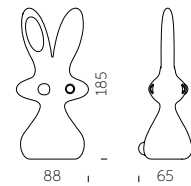
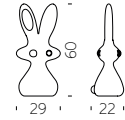

From the creative flair of the great Japanese artist Aki Kuroda, and a collaboration with the Yoyo Maeght Gallery, come the sculptures Bunny and Cosmo Bunny. Big ears and a bewildered gaze, the unmistakable silhouette of Bunny and Cosmo Bunny fills rooms with its adorable charisma. The smaller version, Bunny, and the larger version, Cosmo Bunny, are the perfect synthesis of artistic sculpture, for their unmistakable shape, and industrial production, created in polyethylene through rotational moulding.



GIOTTO MIRROR



Design
ROBERTO PAOLI

Collection
GIOTTO MIRROR 80
GIOTTO MIRROR 80 LIGHT
GIOTTO MIRROR 110
GIOTTO MIRROR 110 LIGHT

category mirror
material polyethylene, mirror

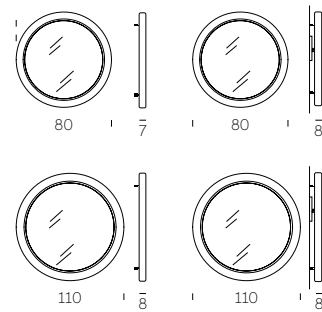

Roberto Paoli's perfect circle becomes an essential and elegant mirror: Giotto Mirror customises contract and residential furnishings thanks to the countless combinations of dimensions and colours. Available in two sizes, Giotto Mirror can give a touch of light in the luminous version, a pop soul in the standard colours or a more glamorous style in the lacquered version.

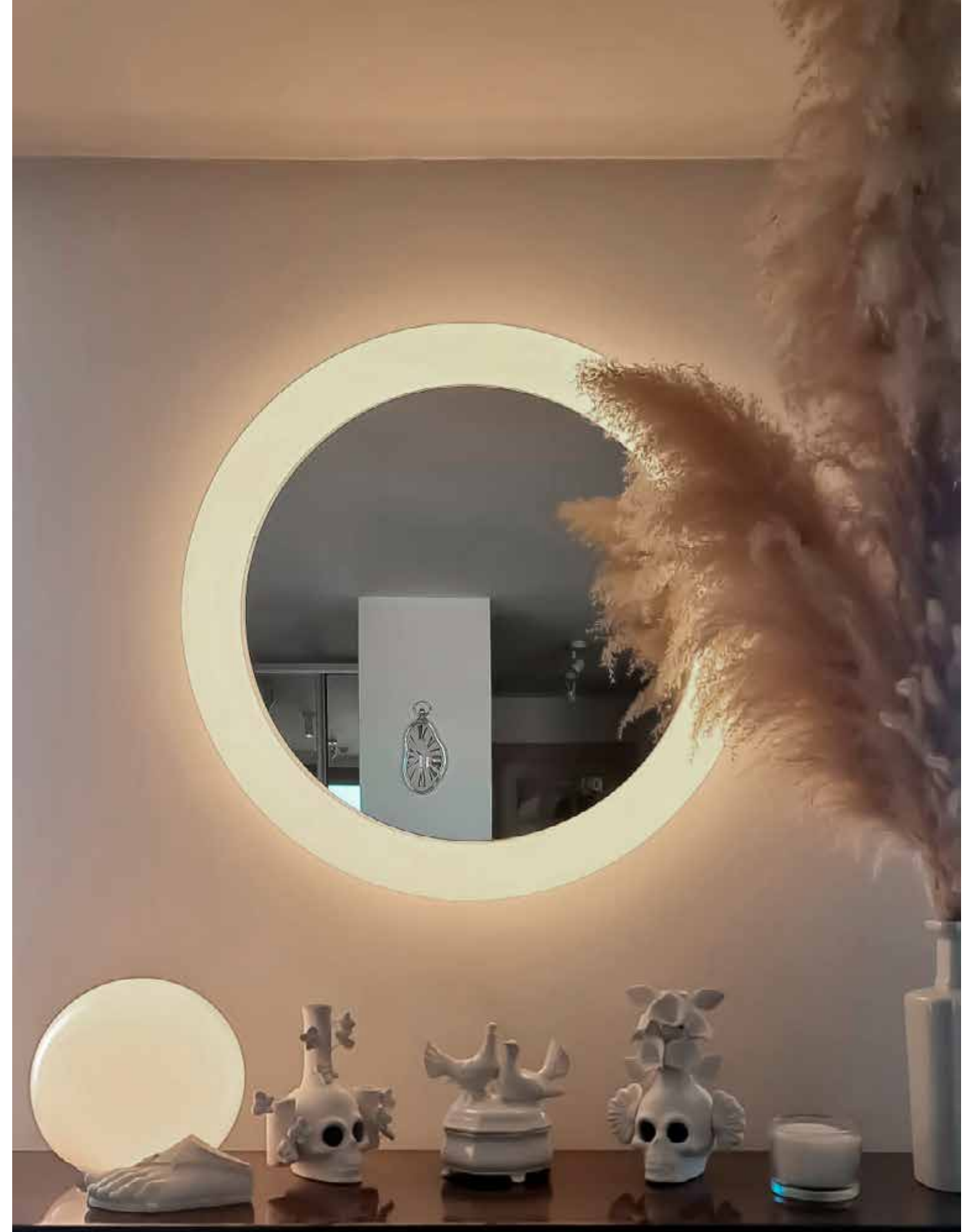

CORDIALE MIRROR

Design
ROBERTO PAOLI

Collection
CORDIALE MIRROR M
CORDIALE MIRROR L

category mirror
material polyethylene, mirror

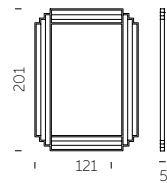
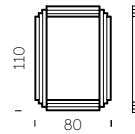

Cordiale collection becomes richer with Cordiale Mirror, the mirror with shapes and grooves that reminds of the Art Deco style of the whole collection. Balanced, refined and with a strong personality, Cordiale Mirror is available in two different sizes and in all standard and lacquered colours.



FRAME OF LOVE



Design
MORO & PIGATTI

category **frame**
material **polyethylene**

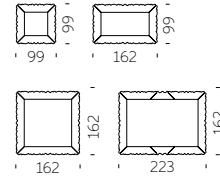

Vintage and sophisticated, Frame of Love is ideal in every kind of settings, both indoor and outdoor, both for domestic rooms or contract world. Thanks to its different dimensions, it is possible to create different compositions with frames in different colours or dimensions.

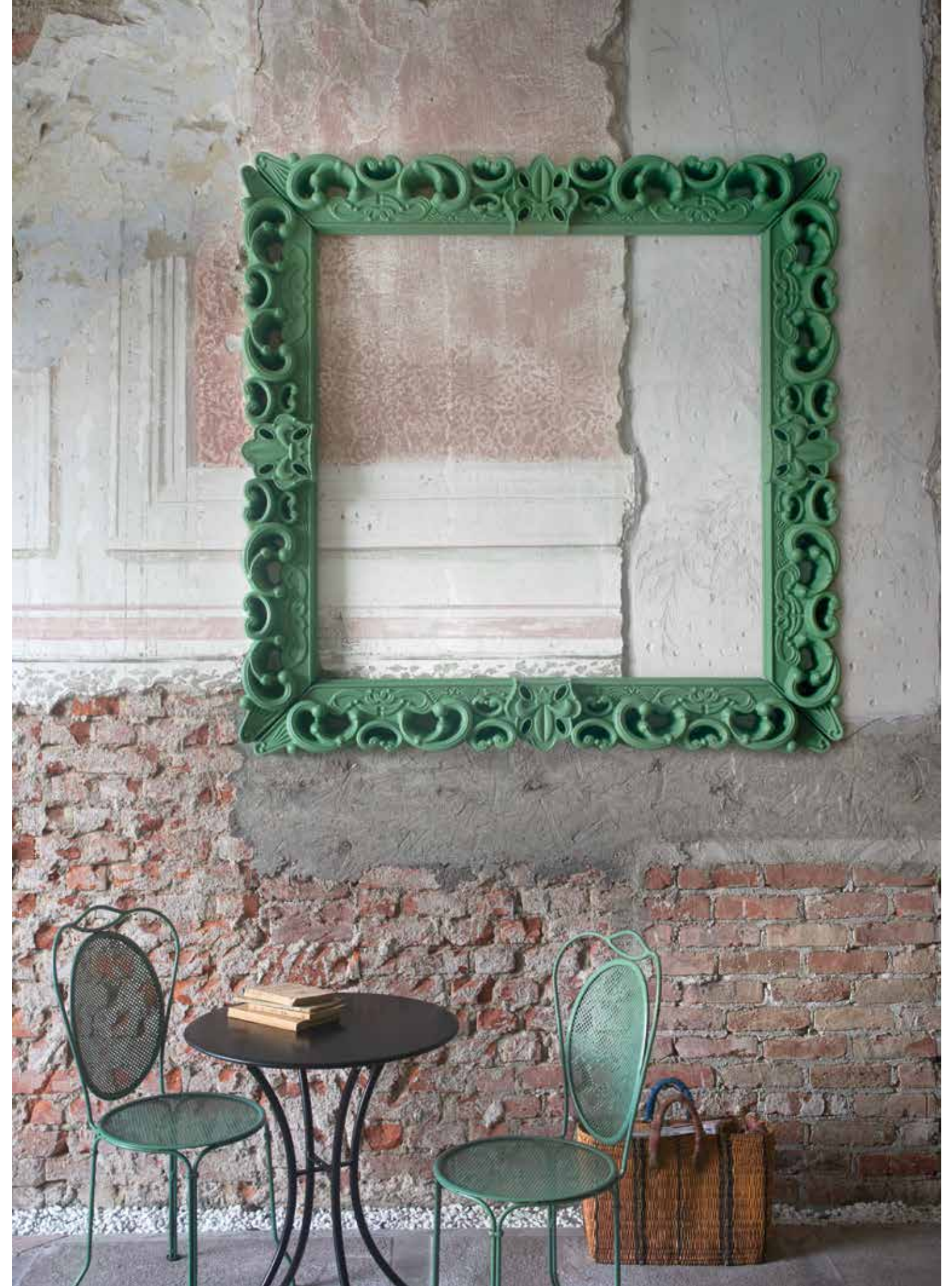

MIRROR OF LOVE



Design
MORO & PIGATTI

category mirror
material polyethylene,
mirror

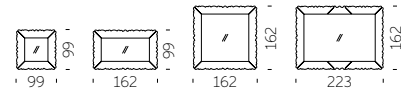

Mirror of Love is the perfect design object to irreverent and contemporary princesses and princes. Mirror of Love is available in four different dimensions, with the same strong personality.



X-POT COLLECTION



Design
SLIDE STUDIO

category pot
material polyethylene

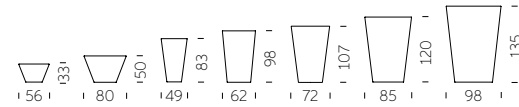

Colourful and minimal: its double wall and round base make X-Pot ideal to every kind of settings. The different dimensions of pots let X-Pot family give a touch of colour and luminous elegance in private gardens or terraces, or to host the guests in hotels, restaurants or shops.



Y-POT COLLECTION



Design
SLIDE STUDIO

category **pot**
material **polyethylene**

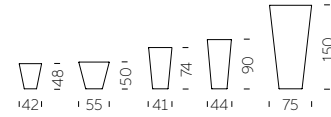

Luminous or lacquered, in lively colours or total white: Y-Pot is the true character to customize indoor or outdoor settings. The square shape and the different dimensions of Y-Pot are suitable for contract projects as well as domestic areas.



QUADRA

Design
GIÒ COLONNA ROMANO

Quadra is a collection of pots that have got a simple and linear shape but the surface is made richer by horizontal streaks, that give facets and movement to the whole product. The simple shape and its elegance make Quadra family ideal in every indoor e outdoor settings.

category **pot**
material **polyethylene**

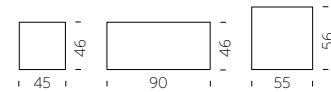

QUADRA SEPARÉ

Design
GIÒ COLONNA ROMANO

category **pot, separè**
material **polyethylene**

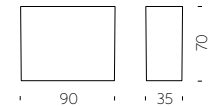

BAMBOO

BAMBOO / TOUS LES TROIS

Bamboo is a flowerpot, versatile and multiple that meets the most diverse needs in terms of space set-up. This colourful flowerpot is a multi-functional item for indoor and outdoor settings: its high and thin structure let Bamboo to be a flowerpot but also a séparè.

Design
TOUS LES TROIS

category **cachepot, séparè**
material **polyethylene**

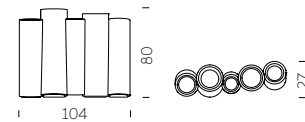

PRIVÉ

Design
SLIDE STUDIO

Privé is a pot with a sinuous design that becomes an elegant divider, when it is completed with panel in plexiglass. Privé is sophisticated but functional at the same time, thanks to its modularity. For this reason it is a perfect option for small and big areas, both indoor and outdoor.

category **pot, séparè**
material **polyethylene, plexiglass**

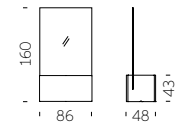

PRIVÉ / SLIDE STUDIO

WAVE POT

Design
SLIDE STUDIO

category **pot**
material **polyethylene**

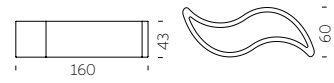

WAVE POT / SLIDE STUDIO

WE LOVE COMPLEMENTS

BASE POT

Design
SLIDE STUDIO

category **pot**
material **polyethylene**

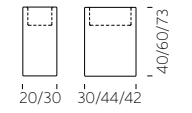

BASE POT / SLIDE STUDIO

WE LOVE COMPLEMENTS

GEAR POT

Design
ANASTASIA IVANYUK

category **pot**
material **polyethylene**

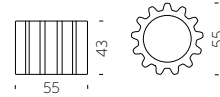

Gear Pot is inspired by the typical shape of a mechanical gear. It is modular: many Gear Pot can be put on top of or beside each other, interlocking like a real gear, to create playful and colourful compositions, turning any space into a unique setting.



GIÒ COLLECTION

Design
GIÒ COLONNA ROMANO

category **pot**
material **polyethylene**

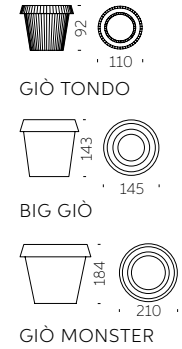

The typical flowerpot becomes oversize and with a multifaceted surface: these are the main features of Giò Tondo, Big Giò and Giò Monster. The macro reinterpretation of pots of everyday use creates huge pots that immediately draw attention to them.



IL VASO COLLECTION



Design
GIÒ COLONNA ROMANO

category **pot**
material **polyethylene**

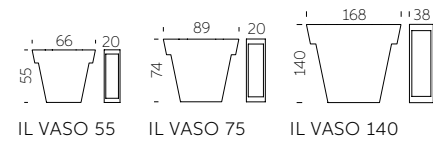

"Versatile and minimalist, Il Vaso uses different dimensional plans to create playful furnishing. The design of Il Vaso is a stylized pot, as a comic book version of the traditional garden item".



BOOKY

BOOKY / GIÒ COLONNA ROMANO



WE LOVE COMPLEMENTS

Design
GIÒ COLONNA ROMANO

category **bookcase**
material **polyethylene**

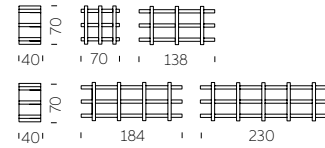

MYBOOK

MYBOOK / GIÒ COLONNA ROMANO



WE LOVE COMPLEMENTS

Design
GIÒ COLONNA ROMANO

category **bookcase**
material **polyethylene**

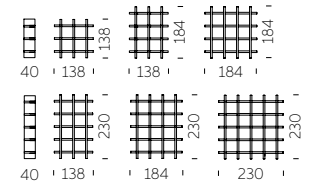

Design
TAEKE HALMA

category **bookcase**
material **polyethylene**

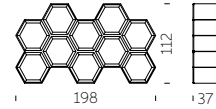

"In the design I tried to create an object that looks playful and light, but it is actually extremely resistant. The hexagonal shape of the individual cells allows the user to personalize each cell, and this will automatically create a rather artistic picture of the various objects as they are not aligned in a strict horizontal fashion".



OPEN CUBE



Design
SLIDE STUDIO

category modular display
material polyethylene

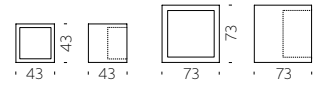

OPEN CUBE / SLIDE STUDIO

WE LOVE COMPLEMENTS

JOKER OF LOVE



Design
MORO & FIGATTI

category modular display
material polyethylene

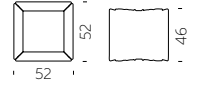

JOKER OF LOVE / MORO & FIGATTI

WE LOVE COMPLEMENTS

LIGHT DRINK



Design
JORGE NAJERA

category **bottle rack**
material **polyethylene**

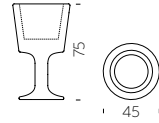

LIGHT DRINK / JORGE NAJERA

WE LOVE COMPLEMENTS

KALIMERA



Design
SLIDE STUDIO

category **bottle rack**
material **polyethylene**



Kalimera is the indispensable co-protagonist to light up cheers with irony and playfulness. Kalimera means "Good morning" in Greek language: thanks to its shape that reminds an eggshell, this bottle rack is ideal to give an informal touch to every indoor and outdoor settings.



KALIMERA / SLIDE STUDIO

WE LOVE COMPLEMENTS

COMPLEMENTS

YOU MAY ALSO LIKE



MYFLOWER

design **FLAVIO LUCCHINI**
category **separè**
material **polyethylene**

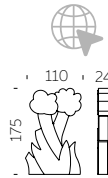

WAVE

design **GIÒ COLONNA ROMANO**
category **bench**
material **polyethylene**

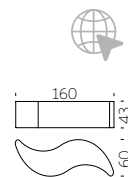

MAG

design **ELI JACOBSON**
category **magazine rack**
material **polyethylene**



IRON

design **SEBASTIAN BERGNE**
category **modular bench**
material **polyethylene**

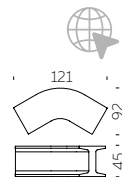

PIXEL

design **STUDIO TONINO**
category **mirror**
material **polyethylene, mirror**

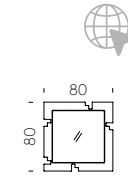

MON AMOUR

design **ALEX SACCHETTI**
category **pot, bottle rack**
material **polyethylene**

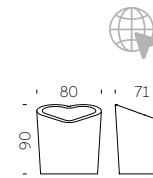

S-POT

design **SLIDE STUDIO**
category **pot**
material **polyethylene**

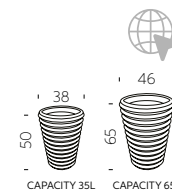

MR. GIÒ + MR. GIÒ SPECCHIO

design **GIÒ COLONNA ROMANO**
category **valet + mirror**
material **polyethylene, mirror**

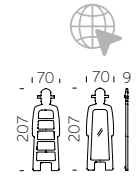

CUBIC YO

design **GIULIO CAPPELLINI**
category **pot**
material **polyethylene with wheels**

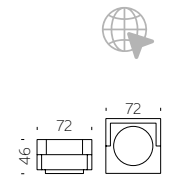

STAR

design **SLIDE STUDIO**
category **pot**
material **polyethylene**

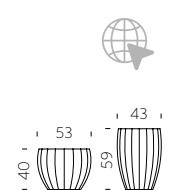

We Love MATERIALS

The high quality of our products comes from the raw material used, but not just that. Over the years, we have embellished polyethylene with unique processing and innovative accessories.

standard polyethylene
special standard polyethylene
lighting polyethylene
special lighting finishing
lacquered matt/glossy
soft polyurethane
textile
hpl

STANDARD POLYETHYLENE

The raw material that represents us best: 100% recyclable low-density polyethylene, which in several colours is completely made from recycled plastic. Our 13 standard colours range from the brightest to more neutral ones, so they suit every need.

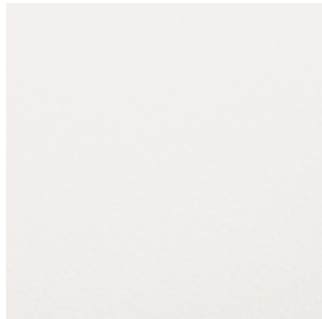

milky white



dove grey



powder blue



malva green



lime green

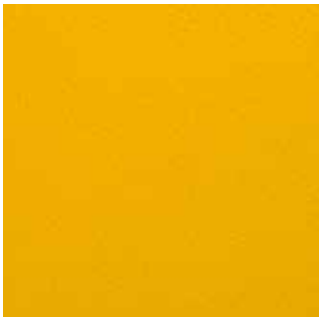

saffron yellow



pumpkin orange



flame red



sweet fuchsia

RECYCLED



jet black



elephant grey



chocolate brown



argil grey



SPECIAL STANDARD POLYETHYLENE

OCEAN



pacific green



atlantic blue

To further enhance certain products, we have created ad hoc colours. Alongside unique processing and shades that give a marble or leather effect to our polyethylene, we have also added new organic or recycled plastic materials.

SECOND LIFE PLASTIC

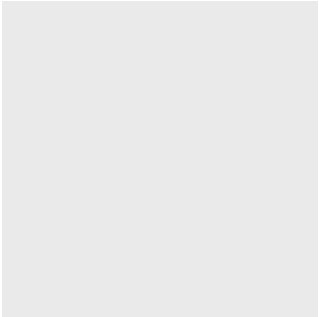

coconut grey



grapes blue

BIOPLASTIC



sahara sand



savannah land



namibian desert



mahogany leather



saddle leather



granito



arabescato



LIGHTING POLYETHYLENE

Warm colours and inviting atmospheres: our bright colours let the light from the bulb inside shine evenly. Light White and Light Vanilla are perfect for indoors and outdoors, while the other colours are exclusively for indoor environments.

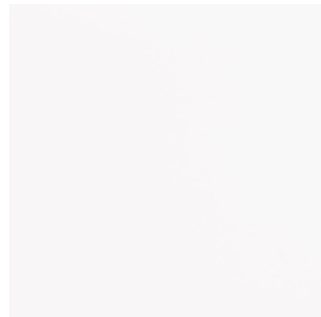

light white

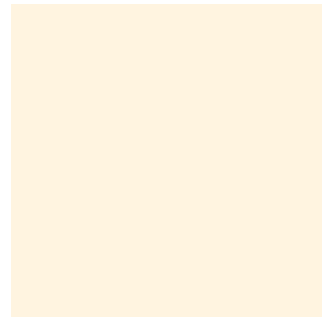

light vanilla



light blue



light green



light yellow



light orange



light red



light pink



SPECIAL LIGHTING FINISHING

To make our lamps more precious, we offer many different processes. With a mulberry paper or marble effect, special lighting finishes embellish some of our products. Special finishes cover the entire surface of the product, adding soft lighting effects.

WE MAKE MATERIALS



PE grey veinings marble



PE red veinings marble



PE japanese paper



SAN transparent blown glass



METHACRYLATE silky white



FIBERGLASS beige grey



FIBERGLASS sapphire blue



FIBERGLASS rubine red



WE MAKE MATERIALS

LACQUERED MATT/GLOSSY CHROMED

The most luxurious finish of all: lacquered colours can be glossy, matt or metallic and add a touch of glamour to our products. Upon request, you can customise the colour of the product as much as possible, choosing a particular RAL, or using several colours.

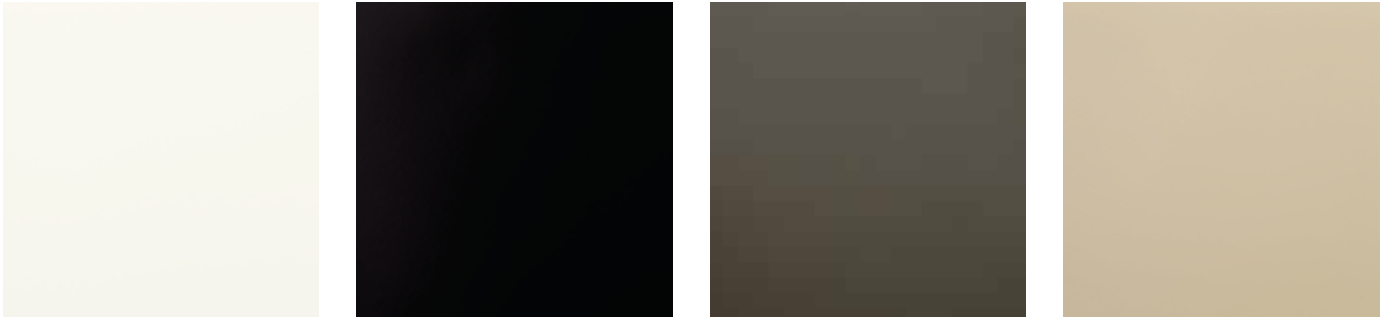
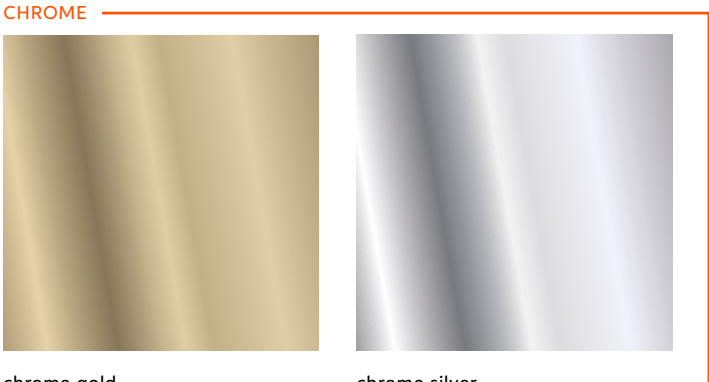

SOFT POLYURETHANE

Our soft polyurethane products are comfortable, perfect for outdoors, and easy to maintain and clean. They are also fireproof and certified in class 1.

Featuring simple or more extravagant shapes, our soft polyurethane products offer a comfortable seat and many different colours.

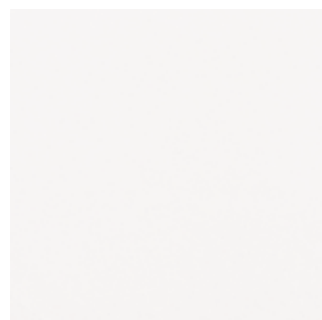

soft white



soft argil



soft yellow

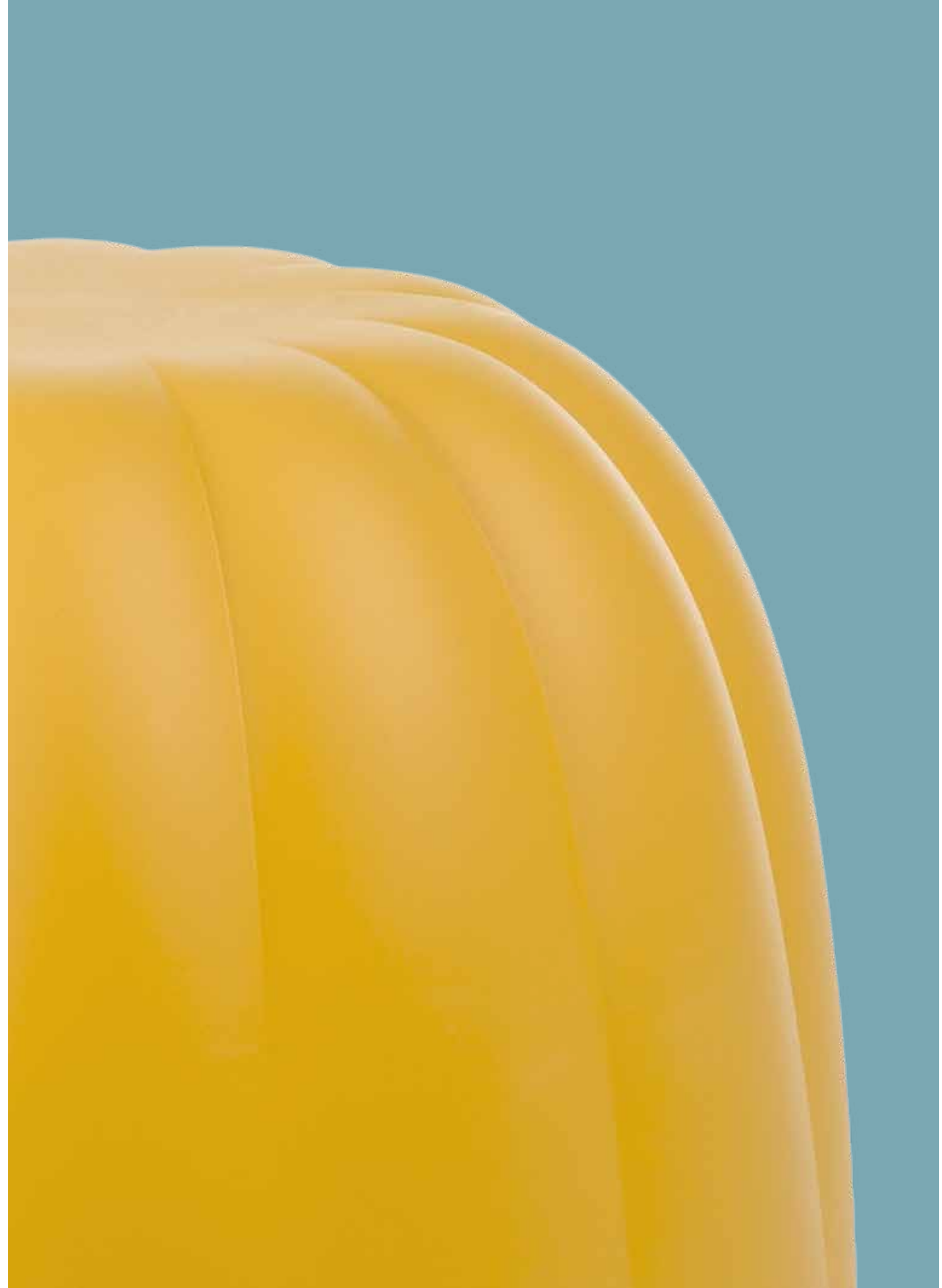

TEXTILE

Seats become increasingly comfortable, without sacrificing any quality: in fact, some of our products have soft cushions covered in waterproof fabric or faux leather. Removable and machine-washable, they help you to relax more outdoors.



cotton white



london brown



dune sand



earth orange



river blue



mineral grey



avena



simmetria avena



rosemary green



simmetria green



ivory white



melange ecru



ECOLEATHER cream



ECOLEATHER light grey



HPL

Our tops are made from HPL, an easy material to clean and maintain, including outdoors, which is lightweight and resistant. They are available in classic white or with nuances that recall the natural textures of stone and wood.

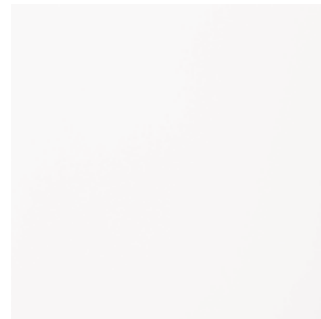

white



calacatta



sierra



cementino



ardesia



imperiale veneto



rovere



wengé

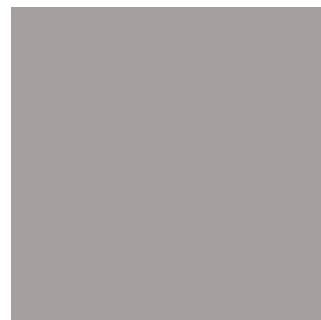

light grey



saddle leather

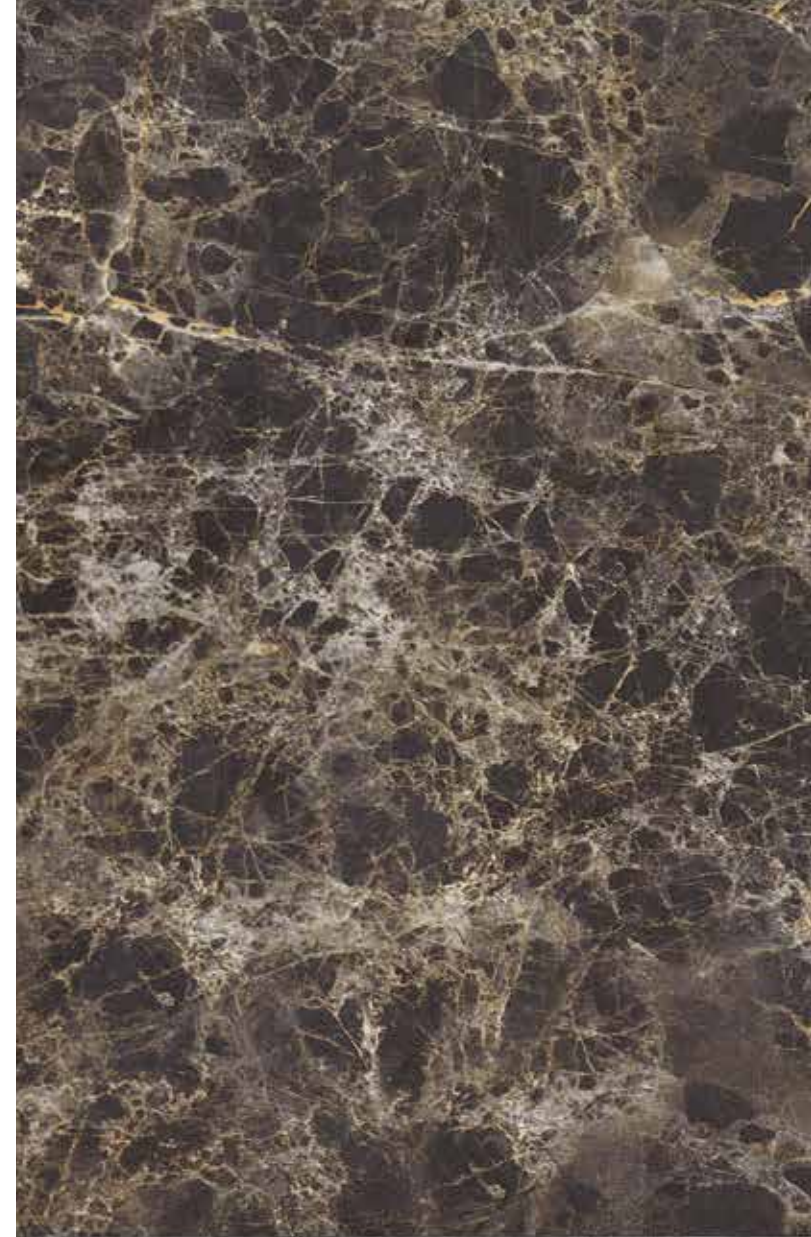

INDEX by TYPE

SEATS

202	AMÉLIE	62	MARA POUF
202	AMÉLIE DUETTO	62	MARA SOFA
202	AMÉLIE PANCHETTA	208	MISTER OF LOVE
202	AMÉLIE SGABELLO	34	PANDORO
202	AMÉLIE SIT UP	80	PONENTE
220	AMORE	210	PRINCESS OF LOVE
218	AMORE OCEAN	206	Q4
215	ATLAS	76	QUEEN OF LOVE
42	BIG KROKO	82	RAP
88	BLOS	82	RAP CHAIR
88	BLOSSY	58	RIBS
214	BOT ONE	58	RIBS UP
90	CHUBBY	185	SNAKE
90	CHUBBY LOW	187	SOFT CUBO
193	CINCIN	186	SOFT SNAKE
38	COLISEUM	214	SUMMERTIME
100	CUBO POUF	101	TARTA
100	DOUBLE U	42	THREEBÙ
215	DOUBLIX	101	TIC TAC
198	DRINK	264	WAVE
215	EXOFA	224	WOW
100	GEAR	214	YPSILON
94	GELÉE	98	ZOE
94	GELÉE GRAND		
94	GELÉE LOUNGE		
184	GIÒ POUF		
190	GLORIA		
191	GLORIA MEETING		
92	HAPPYLIFE		
264	IRON		
86	KAMI ICHI		
86	KAMI SAN		
86	KAMI YON		
200	KONCORD		
42	KROKO		
215	LAZY BONES		
78	LITTLE PRINCE OF LOVE		
79	LITTLE QUEEN OF LOVE		
68	LOW LITA		
68	LOW LITA LOUNGE		
68	LOW LITA LOVE		
62	MARA		

TABLES

228	AMANDA
226	AMBROGIO
202	AMÉLIE UP
101	AMORE TABLE
88	BLOS LOW TABLE
90	CHUBBY SIDE TABLE
26	DUKE OF LOVE
98	ED
192	FIZZ
207	GINO
196	HOPLÀ
200	JET
86	KAMI NI
211	LORD OF LOVE
68	LOW LITA TABLE
62	MARA LOW TABLE
209	MASTER OF LOVE
50	OTTOCENTO

50	OTTOCENTO MINI
56	OTTOCENTO UP
199	PEAK
188	PINT
212	SIR OF LOVE
101	SLOTH
189	SQUARE
101	TAO
101	TARTA LOW TABLE
101	TEA TIME
100	TOY
215	X2

COMPLEMENTS

232	BUNNY/COSMO BUNNY
256	BOOKY
222	ENJOY
238	FRAME OF LOVE
258	HEXA
261	JOKER OF LOVE
263	KALIMERA
262	LIGHT DRINK
264	MAG
240	MIRROR OF LOVE
265	MR. GIÒ
265	MR. GIÒ SPECCHIO
257	MYBOOK
264	MYFLOWER
260	OPEN CUBE
265	PIXEL

COUNTERS

174	BREAK BAR
174	BREAK CORNER
174	BREAK LINE
168	CORDIALE
168	CORDIALE CORNER
168	CORDIALE WELCOME
174	ICE BAR
179	JUMBO BAR
179	JUMBO CORNER

181	ROLLER BAR
178	SNACK BAR
182	SPLAY
180	SWISH
230	TOGETHER

POTS

248	BAMBOO
251	BASE POT
253	BIG GIÒ
88	BLOS POT
265	CUBIC YO
252	GEAR POT
253	GIÒ MONSTER
253	GIÒ TONDO
254	IL VASO
265	MON AMOUR
249	PRIVÉ
246	QUADRA
247	QUADRA SEPARÉ
265	S-POT
265	STAR
42	THREEBÙ POT
250	WAVE POT
242	X-POT
244	Y-POT

LAMPS

120	ACQUAGLOBO
154	ALI BABA STEEL
156	ALI BABA WOOD
130	BALLOON
104	BANANA LEAF
164	BIJOUX
32	BUBO
162	CARMEN
164	CONO
129	CORDIALE APPLIQUE
128	CORDIALE LUMIÈRE
142	CORDIALINA
141	CROWN OF LOVE
161	CUBO

161	CUBO HANGING	126	MURANO HANGING
148	CUCUN	126	MURANO TIGE
138	CUPOLE	162	OTELLO
140	DAME OF LOVE	32	OTELLO MINI
160	DINO	152	PIVOT
137	ELIOS	136	PLUME
155	FIACCOLA ALI BABA	163	PRÊT-À-PORTER
163	FIAMMA	150	PUPA
163	FIAMMETTA	163	PURE
164	FLUO	34	SIRIO
132	FLUX	108	SLIM
132	FLUX HANGING	134	SPIN
132	FLUX UP	112	STILETTO APPLIQUE
116	GIOTTO	112	STILETTO SHARD
120	GLOBO	112	STILETTO X
120	GLOBO HANGING	112	STILETTO Y
120	GLOBO TIGE	165	SUNDAY
165	GLOBO WALL	164	THERE
157	GLOBO WOOD	42	THREEBÙ TOTEM
162	HERE		
165	ICO		
32	JUMPIE		
32	JUNIOR		
165	JUXT		
158	KING OF LOVE		
162	KOKÒ		
163	KOLME		
163	KRISTALINA		
163	KUUSI		
26	LADY OF LOVE		
164	LIGHTTREE		
163	LOVE		
144	LUNA		
159	MADAME OF LOVE		
164	MANHATTAN		
34	MERRY CUBO		
165	MESH		
124	MINERAL		
124	MINERAL HANGING		
124	MINERAL STAND		
124	MINERAL TIGE		
165	MOLLY		
214	MOON		
126	MURANO		

INDEX by LETTER

A

120 ACQUAGLOBO
154 ALI BABA STEEL
156 ALI BABA WOOD
228 AMANDA
226 AMBROGIO
202 AMÉLIE
202 AMÉLIE DUETTO
202 AMÉLIE PANCHETTA
202 AMÉLIE SGABELLO
202 AMÉLIE SIT UP
202 AMÉLIE UP
220 AMORE
218 AMORE OCEAN
101 AMORE TABLE
215 ATLAS

B

248 BAMBOO
104 BANANA LEAF
130 BALLOON
251 BASE POT
253 BIG GIÒ
42 BIG KROKO
164 BIJOUX
88 BLOS
88 BLOS LOW TABLE
88 BLOS POT
88 BLOSSY
256 BOOKY
214 BOT ONE
174 BREAK BAR
174 BREAK CORNER
174 BREAK LINE
32 BUBO
232 BUNNY/COSMO BUNNY

C

162 CARMEN
90 CHUBBY
90 CHUBBY LOW
90 CHUBBY SIDE TABLE

193 CINCIN
38 COLISEUM
164 CONO
168 CORDIALE
129 CORDIALE APPLIQUE
168 CORDIALE CORNER
128 CORDIALE LUMIÈRE
168 CORDIALE WELCOME
142 CORDIALINA
141 CROWN OF LOVE
265 CUBIC YO
161 CUBO
161 CUBO HANGING
100 CUBO POUF
148 CUCUN
138 CUPOLE

D

140 DAME OF LOVE
160 DINO
100 DOUBLE U
215 DOUBLIX
198 DRINK
26 DUKE OF LOVE

E

98 ED
137 ELIOS
222 ENJOY
215 EXOFA

F

155 FIACCOLA ALI BABA
163 FIAMMA
163 FIAMMETTA
192 FIZZ
164 FLUO
132 FLUX
132 FLUX HANGING
132 FLUX UP
238 FRAME OF LOVE

G

100 GEAR
252 GEAR POT
94 GELÉE
94 GELÉE GRAND
94 GELÉE LOUNGE
207 GINO
253 GIÒ MONSTER
184 GIÒ POUF
253 GIÒ TONDO
116 GIOTTO
120 GLOBO
120 GLOBO HANGING
120 GLOBO TIGE
165 GLOBO WALL
157 GLOBO WOOD
190 GLORIA
191 GLORIA MEETING

H

92 HAPPYLIFE
162 HERE
258 HEXA
196 HOPLÀ

I

174 ICE BAR
165 ICO
254 IL VASO
264 IRON

J

200 JET
261 JOKER OF LOVE
179 JUMBO BAR
179 JUMBO CORNER
32 JUMPIE
32 JUNIOR
165 JUXT

K

263 KALIMERA
86 KAMI ICHI
86 KAMI NI
86 KAMI SAN
86 KAMI YON
158 KING OF LOVE
162 KOKÒ
163 KOLME
200 KONCORD
163 KRISTALINA
42 KROKO
163 KUUSI

L

26 LADY OF LOVE
215 LAZY BONES
262 LIGHT DRINK
164 LIGHTTREE
78 LITTLE PRINCE OF LOVE
79 LITTLE QUEEN OF LOVE
211 LORD OF LOVE
163 LOVE
68 LOW LITA
68 LOW LITA LOUNGE
68 LOW LITA LOVE
68 LOW LITA TABLE
144 LUNA

M

159 MADAME OF LOVE
264 MAG
164 MANHATTAN
62 MARA
62 MARA LOW TABLE
62 MARA POUF
62 MARA SOFA
209 MASTER OF LOVE
34 MERRY CUBO
165 MESH
124 MINERAL
124 MINERAL HANGING

124 MINERAL STAND
124 MINERAL TIGE
240 MIRROR OF LOVE
208 MISTER OF LOVE
165 MOLLY
265 MON AMOUR
214 MOON
265 MR. GIÒ
265 MR. GIÒ SPECCHIO
126 MURANO
126 MURANO HANGING
126 MURANO TIGE
257 MYBOOK
264 MYFLOWER

O

260 OPEN CUBE
162 OTELLO
32 OTELLO MINI
50 OTTOCENTO
50 OTTOCENTO MINI
56 OTTOCENTO UP

P

34 PANDORO
199 PEAK
188 PINT
152 PIVOT
265 PIXEL
136 PLUME
80 PONENTE
163 PRÊT-À-PORTER
210 PRINCESS OF LOVE
249 PRIVÉ
150 PUPA
163 PURE

Q

206 Q4
246 QUADRA
247 QUADRA SEPARÉ
76 QUEEN OF LOVE

R

82 RAP
82 RAP CHAIR
58 RIBS
58 RIBS UP
181 ROLLER BAR

S

212 SIR OF LOVE
34 SIRIO
108 SLIM
101 SLOTH
178 SNACK BAR
185 SNAKE
187 SOFT CUBO
186 SOFT SNAKE
134 SPIN
182 SPLAY
189 SQUARE
265 STAR
112 STILETTO APPLIQUE
112 STILETTO SHARD
112 STILETTO X
112 STILETTO Y
214 SUMMERTIME
165 SUNDAY
265 S-POT
180 SWISH

T

101 TAO
101 TARTA
101 TARTA LOW TABLE
101 TEA TIME
164 THERE
42 THREEBÙ
42 THREEBÙ POT
42 THREEBÙ TOTEM
101 TIC TAC
230 TOGETHER
100 TOY

W

264 WAVE
250 WAVE POT
224 WOW

X

242 X-POT
215 X2

Y

244 Y-POT
214 YPSILON

Z

98 ZOE

SLIDE srl - Factory, Showroom & Outlet

Via Lazio 14, 16, 18
20090 Buccinasco (Milano)
Italy

info@slidedesign.it

www.slidedesign.it

 @SLIDEdesignmilano

 @slidedesign

 SLIDE srl

This publication has been produced
and designed by SLIDE srl.

art direction

Ilaria Marelli Design

photo

Miro Zagnoli - www.mirozagnoli.it

thanks to

p.13 - Ph. Carlo Lavatori - Archivio Alessandro Mendini.

thanks to our designers and suppliers

printed by

Rotolito Spa - Milano

© JANUARY 2025 SLIDE Srl

Images and technical specifications included in this catalogue are indicative. SLIDE srl reserves the right to make any changes or improvements without any prior notice. For further information, visit our website or contact our sales department.